

(17)

Table 4 Dimensions of Facings (Other Than Ring Joints, All Pressure Rating Classes)

1	2	3	4	5	6	7	8	9	10	11	12	13	14	15
Nominal Pipe Size	Outside Diameter				Outside Diameter				Height			Minimum Outside Diameter of Raised Portion [Notes (6), (7)]		
	Raised Face Large Male and Large Tongue, R	Small Male, S [Note (1)]	Small Tongue, T	Inside Diameter of Large and Small Tongue, U	Inside Diameter of Small Tongue [Note (1)]	Large Female and Large Groove, W	Small Female, X [Note (1)]	Small Groove, Y	Inside Diameter of Large and Small Groove, Z	Raised Face [Notes (2), (3)]	Large and Small Male and Tongue [Notes (2), (4)]	Depth of Groove or Female [Notes (2), (5)]	Small Female and Groove, K	Large Female and Groove, L
	1/2	34.9	18.3	35.1	25.4	...	36.5	19.9	36.5	23.8	...	...	...	44
3/4	42.9	23.8	42.9	33.3	...	44.4	25.4	44.4	31.8	...	...	...	52	54
1	50.8	30.2	47.8	38.1	...	52.4	31.8	49.2	36.5	...	...	...	57	62
1 1/4	63.5	38.1	57.2	47.6	...	65.1	39.7	58.7	46.0	...	...	...	67	75
1 1/2	73.0	44.4	63.5	54.0	...	74.6	46.0	65.1	52.4	...	...	...	73	84
2	92.1	57.2	82.6	73.0	...	93.7	58.8	84.1	71.4	...	...	...	92	103
2 1/2	104.8	68.3	95.2	85.7	...	106.4	69.8	96.8	84.1	...	...	...	105	116
3	127.0	84.1	117.5	108.0	...	128.6	85.7	119.1	106.4	...	...	...	127	138
3 1/2	139.7	96.8	130.2	120.6	...	141.3	98.4	131.8	119.1	...	...	...	140	151
4	157.2	109.5	144.5	131.8	...	158.8	111.1	146.0	130.2	...	...	...	157	168
5	185.7	136.5	173.0	160.3	...	187.3	138.1	174.6	158.8	...	...	...	186	197
6	215.9	161.9	203.2	190.5	...	217.5	163.5	204.8	188.9	...	...	...	216	227
8	269.9	212.7	254.0	238.1	...	271.5	214.3	255.6	236.5	...	...	...	270	281
10	323.8	266.7	304.8	285.8	...	325.4	268.3	306.4	284.2	...	...	...	324	335
12	381.0	317.5	362.0	342.9	...	382.6	319.1	363.5	341.3	...	...	...	381	392
14	412.8	349.2	393.7	374.6	...	414.3	350.8	395.3	373.1	...	...	...	413	424
16	469.9	400.0	447.5	425.4	...	471.5	401.6	449.3	423.9	...	...	...	470	481
18	533.4	450.8	511.2	489.0	...	535.0	452.4	512.8	487.4	...	...	...	533	544
20	584.2	501.6	558.8	533.4	...	585.8	503.2	560.4	531.8	...	...	...	584	595
22	641.4	...	...	...	...	...	...	...	...	...	...	...	...	...
24	692.2	603.2	666.8	641.4	...	693.7	604.8	668.3	639.8	...	...	...	692	703

## GENERAL NOTES:

- (a) Dimensions are in millimeters. For dimensions in inch units, refer to Table II-4 of Mandatory Appendix II.  
(b) For facing requirements for flanges and flanged fittings, see paras. 6.3 and 6.4 and Figure 6.  
(c) For facing requirements for lapped joints, see para. 6.4.3 and Figure 6.  
(d) For facing tolerances, see para. 7.3.



Global Supply Line - Australia's largest stockist of valves & actuators ASME/API/AS/ISO in all materials.  
Full stock list click [here](http://www.globalsupplyline.com.au). Shipping worldwide [www.globalsupplyline.com.au](http://www.globalsupplyline.com.au)

(17)

**Table 4 Dimensions of Facings (Other Than Ring Joints, All Pressure Rating Classes) (Cont'd)**

---

NOTES:

- (1) For small male and female joints, care should be taken in the use of these dimensions to ensure that the inside diameter of the fitting or pipe is small enough to permit sufficient bearing surface to prevent the crushing of the gasket. This applies particularly on lines where the joint is made on the end of the pipe. The inside diameter of the fitting should match the inside diameter of the pipe as specified by the purchaser. Threaded companion flanges for small male and female joints are furnished with plain face and are threaded with American National Standard Locknut Thread (NPSL).
- (2) See para. 6.4.3 and Figure 6 for thickness and outside diameters of laps.
- (3) The height of the raised face is either 2 mm or 7 mm (see para. 6.4.1).
- (4) The height of the large and small male and tongue is 7 mm.
- (5) The depth of the groove or female is 5 mm.
- (6) The raised portion of the full face may be furnished unless otherwise specified on order.
- (7) Large male and female faces and large tongue and groove are not applicable to Class 150 because of potential dimensional conflicts.

# ANSI B16.5 RING JOINT FACE DIMENSIONS

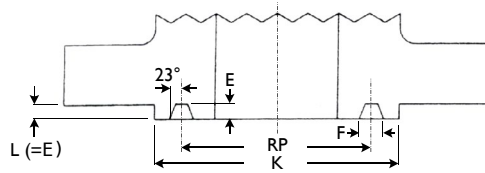

Ring Joint

## RING JOINT FACE DIMENSIONS (mm)

Size	ANSI 150					ANSI 300/600					ANSI 900				
	Ring No.	Pitch Diam.	Width Groove	Depth Groove	RF Diam.	Ring No.	Pitch Diam.	Width Groove	Depth Groove	RF Diam.	Ring No.	Pitch Diam.	Width Groove	Depth Groove	RF Diam.
mm	RN	RP	F	E	K	RN	RP	F	E	K	RN	RP	F	E	K
15						11	34.1	7.1	5.5	50.8	12	39.6	8.7	6.3	60.3
20						13	42.8	8.7	6.3	63.5	14	44.4	8.7	6.3	66.6
25	15	47.6	8.7	6.3	63.5	16	50.8	8.7	6.3	69.8	16	50.8	8.7	6.3	71.4
32	17	57.1	8.7	6.3	73.0	18	60.3	8.7	6.3	79.3	18	60.3	8.7	6.3	80.9
40	19	65.0	8.7	6.3	82.5	20	68.2	8.7	6.3	90.4	20	68.2	8.7	6.3	92.0
50	22	82.5	8.7	6.3	101.6	23	82.5	11.9	7.9	107.9	24	95.2	11.9	7.9	123.8
65	25	101.6	8.7	6.3	120.6	26	101.6	11.9	7.9	127.0	27	107.9	11.9	7.9	136.5
80	29	114.3	8.7	6.3	133.3	31	123.8	11.9	7.9	146.0	31	123.8	11.9	7.9	155.5
90	33	131.7	8.7	6.3	153.9	34	131.7	11.9	7.9	158.7					
100	36	149.2	8.7	6.3	171.4	37	149.2	11.9	7.9	174.6	37	149.2	11.9	7.9	180.9
125	40	171.4	8.7	6.3	193.6	41	180.9	11.9	7.9	209.5	41	180.9	11.9	7.9	215.9
150	43	193.6	8.7	6.3	219.0	45	211.1	11.9	7.9	241.3	45	211.1	11.9	7.9	241.3
200	48	247.6	8.7	6.3	273.0	49	269.8	11.9	7.9	301.6	49	269.8	11.9	7.9	307.9
250	52	304.8	8.7	6.3	330.2	53	323.8	11.9	7.9	355.6	53	323.8	11.9	7.9	361.9
300	56	381.0	8.7	6.3	406.4	57	381.0	11.9	7.9	412.7	57	381.0	11.9	7.9	419.1
350	59	396.8	8.7	6.3	425.4	61	419.1	11.9	7.9	457.2	62	419.1	16.6	11.1	466.7
400	64	454.0	8.7	6.3	482.6	65	469.9	11.9	7.9	508.0	66	469.9	16.6	11.1	523.8
450	68	517.5	8.7	6.3	546.1	69	533.4	11.9	7.9	574.6	70	533.4	19.8	12.7	593.7
500	72	558.8	8.7	6.3	596.9	73	584.2	13.4	9.5	635.0	74	584.2	19.8	12.7	647.7
600	76	673.1	8.7	6.3	711.2	77	692.1	16.6	11.1	749.3	78	692.1	26.9	15.8	771.5

Size	ANSI 1500					ANSI 2500				
	Ring No.	Pitch Diam.	Width Groove	Depth Groove	RF Diam.	Ring No.	Pitch Diam.	Width Groove	Depth Groove	RF Diam.
mm	RN	RP	F	E	K	RN	RP	F	E	K
15	25NB TO 65NB ARE IDENTICAL TO ANSI 900					13	42.8	8.7	6.3	65.0
20						16	50.8	8.7	6.3	73.0
25						18	60.3	8.7	6.3	82.5
32						21	72.2	11.9	7.9	101.6
40						23	82.5	11.9	7.9	114.3
50										26
65					28	111.1	13.4	9.5	149.2	
80	35	136.5	11.9	7.9	168.2	32	127.0	13.4	9.5	168.2
100	39	161.9	11.9	7.9	193.6	38	157.1	16.6	11.1	203.2
125	44	193.6	11.9	7.9	228.6	42	190.5	19.8	12.7	241.3
150	46	211.1	13.4	9.5	247.6	47	228.6	19.8	12.7	279.4
200	50	269.8	16.6	11.1	317.5	51	279.4	23.0	14.2	339.7
250	54	323.8	16.6	11.1	371.4	55	342.9	30.1	17.4	425.4
300	58	381.0	23.0	14.2	438.1	60	406.4	33.3	17.4	495.3
350	63	419.1	26.9	15.8	488.9					
400	67	469.9	30.1	17.4	546.1					
450	71	533.4	30.1	17.4	612.7					
500	75	584.2	33.3	17.4	673.1					
600	79	692.1	36.5	20.6	793.7					



# ANSI B16.5 CLASS 600 FLANGES

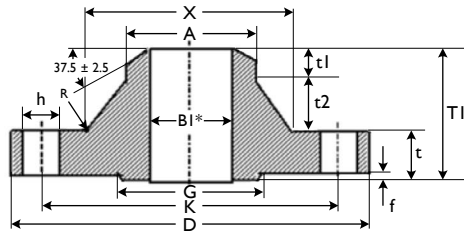

Welding Neck RF

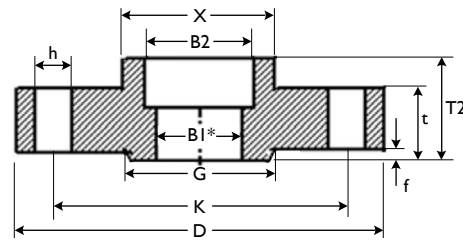

Socket Welding RF

## WELDING NECK RF STD\* DIMENSIONS (mm)

Size		Outside Diam.	Bore Diam. STD	Thick-ness	Total Thick-ness	Neck		Hub		Radius	Holes			Raised Face	
mm	inch	D	BI*	t	T1	Base Diam.	Thick-ness	Thick-ness	Diam.		Diam.	No.	P.C.D	Outside Diam.	Thick-ness
mm	inch	D	BI*	t	T1	X	t2	t1	A	R	h	n	K	G	f
15	½	95.25	15.75	14.22	52.32	38.10	30.48	7.62	21.34	3.05	15.75	4.00	66.55	35.05	6.40
20	¾	117.35	20.83	15.75	57.15	47.75	33.02	8.38	26.67	3.05	19.05	4.00	82.55	42.93	6.40
25	1	123.95	26.67	17.53	61.98	53.85	35.56	8.89	33.53	3.05	19.05	4.00	88.90	50.80	6.40
32	1¼	133.35	35.05	20.57	66.55	63.50	36.83	9.14	42.16	4.83	19.05	4.00	98.55	63.50	6.40
40	1½	155.45	40.89	22.35	69.85	69.85	38.10	9.40	48.26	6.35	22.35	4.00	114.30	73.15	6.40
50	2	165.10	52.58	25.40	73.15	84.07	38.10	9.65	60.45	7.87	19.05	8.00	127.00	91.95	6.40
65	2½	190.50	62.74	28.45	79.25	100.08	40.64	10.16	73.15	7.87	22.35	8.00	149.35	104.65	6.40
80	3	209.55	77.98	31.75	82.55	117.35	40.64	10.16	88.90	9.65	22.35	8.00	168.15	127.00	6.40
90	3½	228.60	90.17	35.05	85.85	133.35	40.64	10.16	101.60	9.65	25.40	8.00	184.15	139.70	6.40
100	4	273.05	102.36	38.10	101.60	152.40	50.80	12.70	114.30	11.18	25.40	8.00	215.90	157.53	6.40
125	5	330.20	128.27	44.45	114.30	188.98	55.88	13.97	141.22	11.18	28.45	8.00	266.70	185.67	6.40
150	6	355.60	154.18	47.75	117.35	222.25	55.63	13.97	168.40	12.70	28.45	12.00	292.10	215.90	6.40
200	8	419.10	202.69	55.63	133.35	273.05	62.23	15.49	219.20	12.70	31.75	12.00	349.25	269.75	6.40
250	10	508.00	254.51	63.50	152.40	342.90	71.12	17.78	273.05	12.70	35.05	16.00	431.80	323.85	6.40
300	12	558.80	304.80	66.55	155.45	400.05	71.12	17.78	323.85	12.70	35.05	20.00	488.95	381.00	6.40
350	14	603.25	336.55	69.85	165.10	431.80	76.20	19.05	355.60	12.70	38.10	20.00	527.05	412.75	6.40
400	16	685.80	387.35	76.20	177.80	495.30	81.28	20.32	406.40	12.70	41.15	20.00	603.25	469.90	6.40
450	18	742.95	438.15	82.55	184.15	546.10	81.28	20.32	457.20	12.70	44.45	20.00	654.05	533.40	6.40
500	20	812.80	488.95	88.90	190.50	609.60	81.28	20.32	508.00	12.70	44.45	24.00	723.90	584.20	6.40

For Ring Groove face dimensions see Page 47. \*See page 48 for bore diameter all schedules (S10 to XXS)

## SOCKET WELDING RF (STD\* and XS\*) DIMENSIONS (mm)

Size		Outside Diam.	Bore Diameter STD		Bore Diameter XS		Thick-ness	Socket Depth	Total Thick-ness	Diam. at Base of Hub	Holes			Raised Face		Net Weight
mm	inch	D	B2	BI	B2	BI	t	Y	T2	X	h	n	K	G	f	kg
15	½	95.25	22.35	15.75	22.35	13.87	14.22	9.65	22.35	38.10	15.75	4.00	66.55	35.05	6.40	0.77
20	¾	117.35	27.69	20.83	27.69	18.85	15.75	11.18	25.40	47.75	19.05	4.00	82.55	42.93	6.40	1.30
25	1	123.95	34.54	26.67	34.54	24.31	17.53	12.70	26.92	53.85	19.05	4.00	88.90	50.80	6.40	1.59
32	1¼	133.35	43.18	35.05	43.18	32.46	20.57	14.22	26.92	63.50	19.05	4.00	98.55	63.50	6.40	2.11
40	1½	155.45	49.53	40.89	49.53	38.10	22.35	15.75	31.75	69.85	22.35	4.00	114.30	73.15	6.40	3.08
50	2	165.10	61.98	52.58	61.98	49.25	25.40	17.53	36.58	84.07	19.05	8.00	127.00	91.95	6.40	3.78
65	2½	190.50	74.68	62.74	74.68	59.00	28.45	19.05	41.15	100.08	22.35	8.00	149.35	104.65	6.40	5.53
80	3	209.55	90.68	77.98	90.68	73.66	31.75	20.57	45.97	117.35	22.35	8.00	168.15	127.00	6.40	7.42
90	3½	228.60	103.38	90.17	103.38	85.45	35.05	22.35	49.28	133.35	25.40	8.00	184.15	139.70	6.40	9.36
100	4	273.05	116.08	102.36	116.08	97.18	38.10	23.88	53.85	152.40	25.40	8.00	215.90	157.53	6.40	15.19
125	5	330.20	143.76	128.27	143.76	122.25	44.45	23.88	60.45	188.98	28.45	8.00	266.70	185.67	6.40	25.58
150	6	355.60	170.69	154.18	170.69	146.33	47.75	26.92	66.55	222.25	28.45	12.00	292.10	215.90	6.40	30.34
200	8	419.10	221.49	202.69	221.49	193.68	55.63	31.75	76.20	273.05	31.75	12.00	349.25	269.75	6.40	45.93
250	10	508.00	276.35	254.51	276.35	247.65	63.50	33.27	85.85	342.90	35.05	16.00	431.80	323.85	6.40	74.45
300	12	558.80	327.15	304.80	327.15	298.45	66.55	39.62	91.95	400.05	35.05	20.00	488.95	381.00	6.40	89.03
350	14	603.25	359.16	336.55	359.16	330.20	69.85	41.40	93.73	431.80	38.10	20.00	527.05	412.75	6.40	104.43
400	16	685.80	410.46	387.35	410.46	381.00	76.20	44.45	106.43	495.30	41.15	20.00	603.25	469.90	6.40	150.03
450	18	742.95	461.77	438.15	461.77	431.80	82.55	49.28	117.35	546.10	44.45	20.00	654.05	533.40	6.40	183.07
500	20	812.80	513.08	489.95	513.08	482.60	88.90	54.10	127.00	609.60	44.45	24.00	723.90	584.20	6.40	232.14
600	24	939.80	615.95	590.55	615.95	584.20	101.60	63.50	139.70	717.55	50.80	24.00	838.20	692.15	6.40	328.13

For Ring Groove face dimensions see Page 47. \*See page 48 for bore diameter all schedules (S10 to XXS)



# ANSI B16.5 CLASS 600 FLANGES

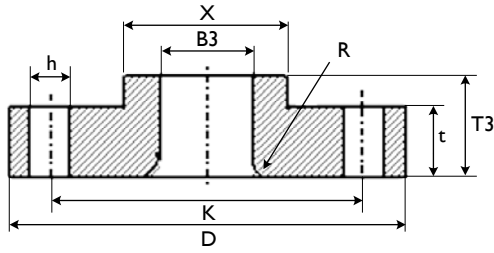

Lap Joint RF

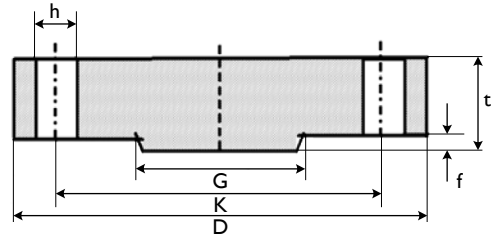

Blind RF

## LAP JOINT RF DIMENSIONS (mm)

Size		Outside Diam.	Bore Diam. STD	Thick-ness	Length thru Hub	Dia. at Base of Hub	Holes			Radius of Fillet	Raised Face		Net Weight
mm	inch						D	B3	t		T3	X	
15	½	95.25	22.86	14.22	22.35	38.10	15.75	4.00	66.55	3.05	35.05	6.40	0.74
20	¾	117.35	28.19	15.75	25.40	47.75	19.05	4.00	82.55	3.05	42.93	6.40	1.25
25	1	123.95	35.05	17.53	26.92	53.85	19.05	4.00	88.90	3.05	50.80	6.40	1.52
32	1¼	133.35	43.69	20.57	28.45	63.50	19.05	4.00	98.55	4.83	63.50	6.40	2.02
40	1½	155.45	50.04	22.35	31.75	69.85	22.35	4.00	114.30	6.35	73.15	6.40	2.96
50	2	165.10	62.48	25.40	36.58	84.07	19.05	8.00	127.00	7.87	91.95	6.40	3.60
65	2½	190.50	75.44	28.45	41.15	100.08	22.35	8.00	149.35	7.87	104.65	6.40	5.21
80	3	209.55	91.44	31.75	45.97	117.35	22.35	8.00	168.15	9.65	127.00	6.40	6.96
90	3½	228.60	104.14	35.05	49.28	133.35	25.40	8.00	184.15	9.65	139.70	6.40	8.78
100	4	273.05	116.84	38.10	53.85	152.40	25.40	8.00	215.90	11.18	157.53	6.40	14.46
125	5	330.20	144.53	44.45	60.45	188.98	28.45	8.00	266.70	11.18	185.67	6.40	24.38
150	6	355.60	171.45	47.75	66.55	222.25	28.45	12.00	292.10	12.70	215.90	6.40	28.71
200	8	419.10	222.25	55.63	76.20	273.05	31.75	12.00	349.25	12.70	269.75	6.40	43.26
250	10	508.00	277.37	63.50	111.25	342.90	35.05	16.00	431.80	12.70	323.85	6.40	76.28
300	12	558.80	328.17	66.55	117.35	400.05	35.05	20.00	488.95	12.70	381.00	6.40	91.71
350	14	603.25	360.17	69.85	127.00	431.80	38.10	20.00	527.05	12.70	412.75	6.40	109.93
400	16	685.80	411.23	76.20	139.70	495.30	41.15	20.00	603.25	12.70	469.90	6.40	157.46
450	18	742.95	462.28	82.55	152.40	546.10	44.45	20.00	654.05	12.70	533.40	6.40	191.22
500	20	812.80	514.35	88.90	165.10	609.60	44.45	24.00	723.90	12.70	584.20	6.40	244.41
600	24	939.90	615.95	101.60	184.15	717.55	50.80	24.00	838.20	12.70	692.15	6.40	349.66

For Ring Groove face dimensions see Page 47.

## BLIND RF DIMENSIONS (mm)

Size		Outside Diameter	Thickness	Holes			Raised Face		Net Weight
mm	inch			D	t	Diameter	Number	P.C.D	
15	½	95.25	14.22	15.75	4.00	66.55	35.05	6.40	0.76
20	¾	117.35	15.75	19.05	4.00	82.55	42.93	6.40	1.27
25	1	123.95	17.53	19.05	4.00	88.90	50.80	6.40	1.60
32	1¼	133.35	20.57	19.05	4.00	98.55	63.50	6.40	3.23
40	1½	155.45	22.35	22.35	4.00	114.30	73.15	6.40	3.26
50	2	165.10	25.40	19.05	8.00	127.00	91.95	6.40	4.14
65	2½	190.50	28.45	22.35	8.00	149.35	104.65	6.40	6.09
80	3	209.55	31.75	22.35	8.00	168.15	127.00	6.40	8.44
90	3½	228.60	35.05	25.40	8.00	169.15	139.70	6.40	10.94
100	4	273.05	38.10	25.40	8.00	200.15	157.53	6.40	17.27
125	5	330.20	44.45	28.45	8.00	234.95	185.67	6.40	29.46
150	6	355.60	47.75	28.45	12.00	269.75	215.90	6.40	36.19
200	8	419.10	55.63	31.75	12.00	330.20	269.75	6.40	58.94
250	10	508.00	63.50	35.05	16.00	387.35	323.85	6.40	97.44
300	12	558.80	66.55	35.05	20.00	450.85	381.00	6.40	123.72
350	14	603.25	69.85	38.10	20.00	514.35	412.75	6.40	150.89
400	16	685.80	76.20	41.15	20.00	571.50	469.90	6.40	213.69
450	18	742.95	82.55	44.45	24.00	628.65	533.40	6.40	267.93
500	20	812.80	88.90	44.45	24.00	685.80	584.20	6.40	349.47
600	24	939.90	101.60	50.80	24.00	812.80	692.15	6.40	533.21

For Ring Groove face dimensions see Page 47.



# ANSI B16.5 CLASS 600 FLANGES

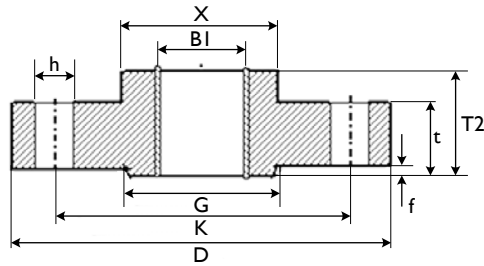

Threaded RF

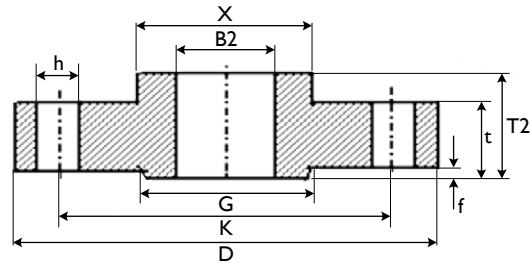

Slip On RF

## THREADED RF DIMENSIONS (mm)

Size		Outside Diam.	Bore Diam. STD	Thick-ness	Total Thick-ness	Dia. at Base of Hub	Thread Length	Holes			Raised Face		Net Weight
mm	inch							Diam.	No.	P.C.D	Outside Diam.	Thick-ness	
mm	inch	D	BI	t	T2	X	Q	h	n	K	G	f	Kg
15	½	95.25	22.35	14.22	22.35	38.10	15.75	15.75	4.00	66.55	35.05	6.40	0.74
20	¾	117.35	27.69	15.75	25.40	47.75	15.75	19.05	4.00	82.55	42.93	6.40	1.25
25	1	123.95	34.54	17.53	26.92	53.85	17.53	19.05	4.00	88.90	50.80	6.40	1.53
32	1¼	133.35	43.18	20.57	28.45	63.50	20.57	19.05	4.00	98.55	63.50	6.40	2.02
40	1½	155.45	49.53	22.35	31.75	69.85	22.35	22.35	4.00	114.30	73.15	6.40	2.97
50	2	165.10	61.98	25.40	36.58	84.07	28.45	19.05	8.00	127.00	91.95	6.40	3.62
65	2½	190.50	74.68	28.45	41.15	100.08	31.75	22.35	8.00	149.35	104.65	6.40	5.24
80	3	209.55	90.68	31.75	45.97	117.35	35.05	22.35	8.00	168.15	127.00	6.40	7.00
90	3½	228.60	103.38	35.05	49.28	133.35	39.62	25.40	8.00	184.15	139.70	6.40	8.84
100	4	273.05	116.08	38.10	53.85	152.40	41.15	25.40	8.00	215.90	157.23	6.40	14.52
125	5	330.20	143.76	44.45	60.45	188.98	47.75	28.45	8.00	266.70	185.67	6.40	24.47
150	6	355.60	170.69	47.75	66.55	222.25	50.80	28.45	12.00	292.10	215.90	6.40	28.82
200	8	419.10	221.49	55.63	76.20	273.05	57.15	31.75	12.00	349.25	269.75	6.40	43.43
250	10	508.00	276.35	63.50	85.85	342.90	65.02	35.05	16.00	431.80	323.85	6.40	70.23
300	12	558.80	327.15	66.55	91.95	400.05	69.85	35.05	20.00	488.95	381.00	6.40	83.92
350	14	603.25	359.16	69.85	93.73	431.80	60.45	38.10	20.00	527.05	412.75	6.40	98.74
400	16	685.80	410.46	76.20	106.43	495.30	77.72	41.15	20.00	603.25	469.90	6.40	142.27
450	18	742.95	461.77	82.55	117.35	546.10	79.25	44.45	20.00	654.05	533.40	6.40	173.32
500	20	812.80	513.08	88.90	127.00	609.60	82.55	44.45	24.00	723.90	584.20	6.40	220.33
600	24	939.90	615.95	101.60	139.70	717.55	91.95	50.80	24.00	838.20	692.15	6.40	312.53

For Ring Groove face dimensions see Page 47.

## SLIP ON RF DIMENSIONS (mm)

Size		Outside Diam.	Bore Diam.	Thick-ness	Total Thick-ness	Dia. at Base of Hub	Holes			Raised Face		Net Weight
mm	inch						Diam.	Number	P.C.D	Outside Diam.	Thick-ness	
mm	inch	D	B2	t	T2	X	h	n	K	G	f	Kg
15	½	95.25	22.35	14.22	22.35	38.10	15.75	4.00	66.55	35.05	6.40	0.74
20	¾	117.35	27.69	15.75	25.40	47.75	19.05	4.00	82.55	42.93	6.40	1.25
25	1	123.95	34.54	17.53	26.92	53.85	19.05	4.00	88.90	50.80	6.40	1.53
32	1¼	133.35	43.18	20.57	28.45	63.50	19.05	4.00	98.55	63.50	6.40	2.02
40	1½	155.45	49.53	22.35	31.75	69.85	22.35	4.00	114.30	73.15	6.40	2.97
50	2	165.10	61.98	25.40	36.58	84.07	19.05	8.00	127.00	91.95	6.40	3.62
65	2½	190.50	74.68	28.45	41.15	100.08	22.35	8.00	149.35	104.65	6.40	5.24
80	3	209.55	90.68	31.75	45.97	117.35	22.35	8.00	168.15	127.00	6.40	7.00
90	3½	228.60	103.38	35.05	49.58	133.35	25.40	8.00	169.15	139.70	6.40	8.84
100	4	273.05	116.08	38.10	53.85	152.40	25.40	8.00	215.90	157.53	6.40	14.52
125	5	330.20	143.76	44.45	80.45	188.98	28.45	8.00	266.70	185.67	6.40	24.47
150	6	355.60	170.69	47.75	66.55	222.25	28.45	12.00	292.10	215.90	6.40	28.82
200	8	419.10	221.49	55.63	76.20	273.05	31.75	12.00	349.25	269.75	6.40	43.43
250	10	508.00	276.35	63.50	85.85	342.90	35.05	16.00	431.80	323.85	6.40	70.23
300	12	558.80	327.15	66.55	91.95	400.05	35.05	20.00	488.95	381.00	6.40	83.92
350	14	603.25	359.16	69.85	93.73	431.80	38.10	20.00	527.05	412.75	6.40	98.74
400	16	685.80	410.46	76.20	106.43	495.30	41.15	20.00	603.25	469.90	6.40	142.27
450	18	742.95	461.77	82.55	117.35	546.10	44.45	20.00	654.05	533.40	6.40	173.32
500	20	812.80	513.08	88.90	127.00	609.60	44.45	24.00	723.90	584.20	6.40	220.33
600	24	939.90	615.95	101.60	139.70	717.55	50.80	24.00	838.20	692.15	6.40	312.53

For Ring Groove face dimensions see Page 47.

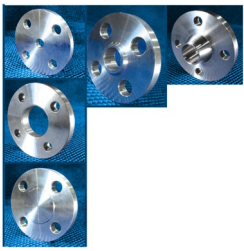

# ANSI B16.5 CLASS 900 FLANGES

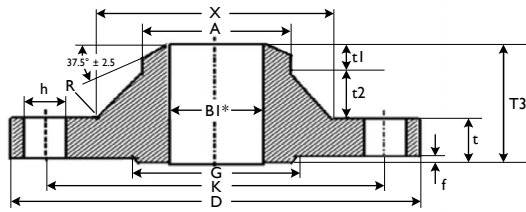

Welding Neck RF

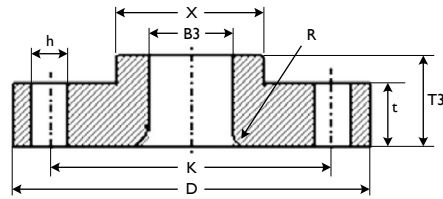

Lap Joint RF

## WELDING NECK RF STD\* DIMENSIONS (mm)

Size		Outside Diam.	Bore Diam. STD	Thick-ness	Total Thick-ness	Neck		Hub		Radius	Holes			Raised Face		Net Weight
mm	inch					D	BI*	t	TI		X	t2	t1	A	R	
15	½	120.65	15.80	22.35	60.45	38.10	30.48	7.62	21.34	3.05	22.35	4.00	82.55	35.05	6.40	1.88
20	¾	130.05	20.93	25.40	69.85	44.45	35.56	8.89	26.67	3.05	22.35	4.00	88.90	42.93	6.40	2.54
25	1	149.35	26.64	28.45	73.15	52.32	35.76	8.94	33.53	3.05	25.40	4.00	101.60	50.80	6.40	3.72
32	1¼	158.75	35.05	28.45	73.15	63.50	35.76	8.94	42.16	4.83	25.40	4.00	111.25	63.50	6.40	4.29
40	1½	177.80	40.89	31.75	82.55	69.85	40.64	10.16	48.56	6.35	28.45	4.00	123.95	73.15	6.40	5.94
50	2	215.90	52.50	38.10	101.60	104.65	50.80	12.70	60.45	7.87	25.40	8.00	165.10	91.95	6.40	10.81
65	2½	244.35	62.71	41.15	104.65	123.95	50.80	12.70	73.15	7.87	28.45	8.00	190.50	104.65	6.40	14.92
80	3	241.30	77.93	38.10	101.60	127.00	50.80	12.70	88.90	9.65	25.40	8.00	190.50	127.00	6.40	13.60
100	4	292.10	102.26	44.45	114.30	158.75	55.88	13.97	114.30	11.18	31.75	8.00	234.95	157.23	6.40	22.37
125	5	349.25	128.19	50.80	127.00	190.50	60.96	15.24	141.22	11.18	35.05	8.00	279.40	185.67	6.40	35.90
150	6	381.00	154.05	55.63	139.70	234.95	67.26	16.81	168.40	12.70	31.75	12.00	317.50	215.90	6.40	46.98
200	8	469.90	202.72	63.50	162.05	298.45	78.84	19.71	219.20	12.70	38.10	12.00	393.70	269.75	6.40	80.07
250	10	546.10	254.51	69.85	184.15	368.30	91.44	22.86	273.05	12.70	38.10	16.00	469.90	323.85	6.40	117.90
300	12	609.60	304.80	79.25	200.15	419.10	96.72	24.18	323.85	12.70	38.10	20.00	533.40	381.00	6.40	156.80
350	14	641.35	336.55	85.85	212.85	450.85	101.60	25.40	355.60	12.70	41.15	20.00	558.80	412.75	6.40	179.94
400	16	704.85	387.35	88.90	215.90	508.00	101.60	25.40	406.40	12.70	44.45	20.00	615.95	469.90	6.40	216.91
450	18	787.40	438.15	101.60	228.60	565.15	101.60	25.40	457.20	12.70	50.80	20.00	685.80	533.40	6.40	293.63
500	20	857.25	488.95	107.95	247.65	622.30	111.76	27.94	508.00	12.70	53.85	20.00	749.30	584.20	6.40	364.11
600	24	1041.40	590.55	139.70	292.10	749.30	121.92	30.48	609.60	12.70	66.55	20.00	901.70	692.15	6.40	666.57

For Ring Groove face dimensions see Page 47. \*See page 48 for bore diameter all schedules (S10 to XXS)

## LAP JOINT RF DIMENSIONS (mm)

Size		Outside Diam.	Bore Diam.	Thick-ness	Length thru Hub	Dia. at Base of Hub	Holes			Radius of Fillet	Raised Face		Net Weight
mm	inch						D	B2	t		T3	X	
15	½	120.65	22.86	22.35	31.75	38.10	22.35	4.00	82.55	3.05	35.05	6.40	1.74
20	¾	130.05	28.19	25.40	35.05	44.45	22.35	4.00	88.90	3.05	42.93	6.40	2.32
25	1	149.35	35.05	28.45	41.15	52.32	25.40	4.00	101.60	3.05	50.80	6.40	3.42
32	1¼	158.75	43.69	28.45	41.15	63.50	25.40	4.00	111.25	4.83	63.50	6.40	3.88
40	1½	177.80	50.04	31.75	44.45	69.85	28.45	4.00	123.95	6.35	73.15	6.40	5.36
50	2	215.90	62.48	38.10	57.15	104.65	25.40	8.00	165.10	7.87	91.95	6.40	9.83
65	2½	244.35	75.44	41.15	63.50	123.95	28.45	8.00	190.50	7.87	104.65	6.40	13.60
80	3	241.30	91.44	38.10	53.85	127.00	25.40	8.00	190.50	9.65	127.00	6.40	11.56
100	4	292.10	116.84	44.45	69.85	158.75	31.75	8.00	234.95	11.18	157.23	6.40	19.67
125	5	349.25	144.53	50.80	79.25	190.50	35.05	8.00	279.40	11.18	185.67	6.40	31.82
150	6	381.00	171.45	55.63	85.85	234.95	31.75	8.00	317.50	12.70	215.90	6.40	41.04
200	8	469.90	222.25	63.50	114.30	298.45	38.10	12.00	393.70	12.70	269.75	6.40	73.63
250	10	546.10	277.37	69.85	127.00	368.30	38.10	16.00	469.90	12.70	323.85	6.40	107.08
300	12	609.60	328.17	79.25	142.75	419.10	38.10	20.00	533.40	12.70	381.00	6.40	142.84
350	14	641.35	360.17	85.85	155.45	450.85	41.15	20.00	558.80	12.70	412.75	6.40	164.28
400	16	704.85	411.23	88.90	165.10	508.00	44.45	20.00	615.95	12.70	469.90	6.40	201.77
450	18	787.40	462.28	101.60	190.50	565.15	50.80	20.00	685.80	12.70	533.40	6.40	282.88
500	20	857.25	514.35	107.95	209.55	622.30	53.85	24.00	749.30	12.70	584.20	6.40	354.29
600	24	1041.40	615.95	139.70	266.70	749.30	66.55	24.00	901.70	12.70	692.15	6.40	677.48

For Ring Groove face dimensions see Page 47.

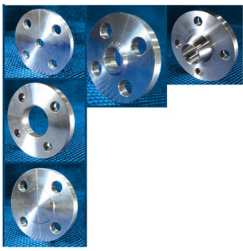

# ANSI B16.5 CLASS 900 FLANGES

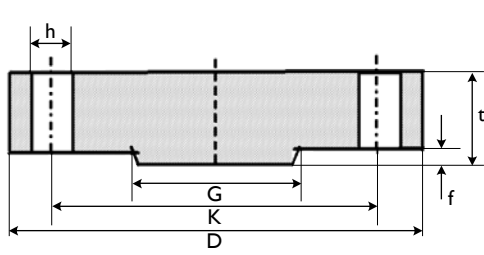

Blind RF

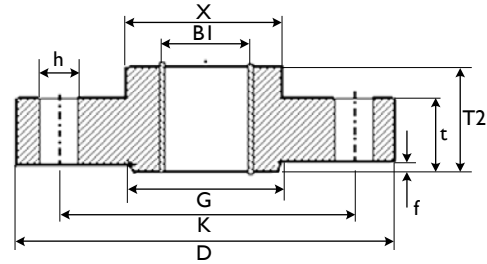

Threaded RF

## BLIND RF DIMENSIONS (mm)

Size		Outside Diameter	Thickness	Holes			Raised Face		Net Weight
				Diameter	Number	P.C.D	Outside Diameter	Thickness	
mm	inch	D	t	h	n	K	G	f	Kg
15	½	120.65	22.35	22.35	4.00	82.55	35.05	6.40	1.78
20	¾	130.05	25.40	22.35	4.00	88.90	42.93	6.40	2.41
25	1	149.35	28.45	25.40	4.00	101.60	50.80	6.40	3.56
32	1¼	158.75	28.45	25.40	4.00	111.25	63.50	6.40	4.13
40	1½	177.80	31.75	28.45	4.00	123.95	73.15	6.40	5.76
50	2	215.90	38.10	25.40	8.00	165.10	91.95	6.40	10.07
65	2½	244.35	41.15	28.45	8.00	190.50	104.65	6.40	13.93
80	3	241.30	38.10	25.40	8.00	190.50	127.00	6.40	13.10
100	4	292.10	44.45	31.75	8.00	234.95	157.23	6.40	22.14
125	5	349.25	50.80	35.05	8.00	279.40	185.67	6.40	36.47
150	6	381.00	55.63	31.75	12.00	317.50	215.90	6.40	47.46
200	8	469.90	63.50	38.10	12.00	393.70	269.75	6.40	82.47
250	10	546.10	69.85	38.10	16.00	469.90	323.85	6.40	122.54
300	12	609.60	79.25	38.10	20.00	533.40	381.00	6.40	173.07
350	14	641.35	85.85	41.15	20.00	558.80	412.75	6.40	206.46
400	16	704.85	88.90	44.45	20.00	615.95	469.90	6.40	259.29
450	18	787.40	101.60	50.80	20.00	685.80	533.40	6.40	367.18
500	20	857.25	107.95	53.85	20.00	749.30	584.20	6.40	463.86
600	24	1041.40	139.70	66.55	20.00	901.70	692.15	6.40	876.56

For Ring Groove face dimensions see Page 47.

## THREADED RF DIMENSIONS (mm)

Size		Outside Diam.	Bore Diam.	Thick-ness	Total Thick-ness	Dia. at Base of Hub	Thread Length	Holes			Raised Face		Net Weight
								Diam.	Number	P.C.D	Outside Diam.	Thick-ness	
mm	inch	D	B2	t	T2	X	Q	h	n	K	G	f	Kg
15	½	120.65	22.35	22.35	31.75	38.10	22.35	22.35	4.00	82.55	35.05	6.40	1.75
20	¾	130.05	27.69	25.40	35.05	44.45	25.40	22.35	4.00	88.90	42.93	6.40	2.33
25	1	149.35	34.54	28.45	41.15	52.32	28.45	25.40	4.00	101.60	50.80	6.40	3.43
32	1¼	158.75	43.18	28.45	41.15	63.50	30.23	25.40	4.00	111.25	63.50	6.40	3.90
40	1½	177.80	49.53	31.75	44.45	69.85	31.75	28.45	4.00	123.95	73.15	6.40	5.38
50	2	215.90	61.98	38.10	57.15	104.65	38.10	25.40	8.00	165.10	91.95	6.40	9.85
65	2½	244.35	74.68	41.15	63.50	123.95	47.75	28.45	8.00	190.50	104.65	6.40	13.65
80	3	241.30	90.68	38.10	53.85	127.00	41.15	25.40	8.00	190.50	127.00	6.40	11.61
100	4	292.10	116.08	44.45	69.85	158.75	47.75	31.75	8.00	234.95	157.23	6.40	19.76
125	5	349.25	143.76	50.80	79.25	190.50	53.85	35.05	8.00	279.40	185.67	6.40	31.93
150	6	381.00	170.69	55.63	85.85	234.95	57.15	31.75	8.00	317.50	215.90	6.40	41.19
200	8	469.90	221.49	63.50	101.60	298.45	63.50	38.10	12.00	393.70	269.75	6.40	70.75
250	10	546.10	276.35	69.85	107.95	368.30	71.37	38.10	16.00	469.90	323.85	6.40	100.58
300	12	609.60	327.15	79.25	117.35	419.10	76.20	38.10	20.00	533.40	381.00	6.40	132.70
350	14	641.35	359.16	85.85	130.05	450.85	82.55	41.15	20.00	558.80	412.75	6.40	153.37
400	16	704.85	410.46	88.90	133.35	508.00	85.85	44.45	20.00	615.95	469.90	6.40	184.90
450	18	787.40	461.77	101.60	152.40	565.15	88.90	50.80	20.00	685.80	533.40	6.40	258.51
500	20	857.25	513.08	107.95	158.75	622.30	91.95	53.85	24.00	749.30	584.20	6.40	317.19
600	24	1041.40	615.95	139.70	203.20	749.30	101.60	66.55	24.00	901.70	692.15	6.40	606.21

For Ring Groove face dimensions see Page 47.





# ANSI B16.5 CLASS 900 FLANGES

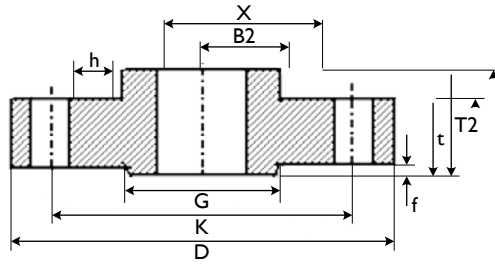

Slip On RF

## SLIP ON RF DIMENSIONS (mm)

Size		Outside Diam.	Bore Diam.	Thick-ness	Total Thick-ness	Dia. at Base of Hub	Holes			Raised Face		Net Weight
mm	inch						D	B2	t	T2	X	
15	½	120.65	22.35	22.35	31.75	38.10	22.35	4.00	82.55	35.05	6.40	1.75
20	¾	130.05	27.69	25.40	35.05	44.45	22.35	4.00	88.90	42.93	6.40	2.33
25	1	149.35	34.54	28.45	41.15	52.32	25.40	4.00	101.60	50.80	6.40	3.43
32	1¼	158.75	43.18	28.45	41.15	63.50	25.40	4.00	111.25	63.50	6.40	3.90
40	1½	177.80	49.53	31.75	44.45	69.85	28.45	4.00	123.95	73.15	6.40	5.38
50	2	215.90	61.98	38.10	57.15	104.65	25.40	8.00	165.10	91.95	6.40	9.85
65	2½	244.35	74.68	41.15	63.50	123.95	28.45	8.00	190.50	104.65	6.40	13.65
80	3	241.30	90.68	38.10	53.85	127.00	25.40	8.00	190.50	127.00	6.40	11.61
100	4	292.10	116.08	44.45	69.85	158.75	31.75	8.00	234.95	157.23	6.40	19.76
125	5	349.25	143.76	50.80	79.25	190.50	35.05	8.00	279.40	185.67	6.40	31.93
150	6	381.00	170.69	55.63	85.85	234.95	31.75	8.00	317.50	215.90	6.40	41.19
200	8	469.90	221.49	63.50	101.60	298.45	38.10	12.00	393.70	269.75	6.40	70.75
250	10	546.10	276.35	69.85	107.95	368.30	38.10	16.00	469.90	323.85	6.40	100.58
300	12	609.60	327.15	79.25	117.35	419.10	38.10	20.00	533.40	381.00	6.40	132.70
350	14	641.35	359.16	85.85	130.05	450.85	41.15	20.00	558.80	412.75	6.40	153.37
400	16	704.85	410.46	88.90	133.35	508.00	44.45	20.00	615.95	469.90	6.40	184.90
450	18	787.40	461.77	101.60	152.40	565.15	50.80	20.00	685.80	533.40	6.40	258.51
500	20	857.25	513.08	107.95	158.75	622.30	53.85	20.00	749.30	584.20	6.40	317.19
600	24	1041.40	615.95	139.70	203.20	749.30	66.55	20.00	901.70	692.15	6.40	606.21

For Ring Groove face dimensions see Page 47.

## SOCKET WELD

See Class 1500, is same up to 65NB

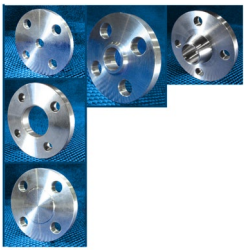

# ANSI B16.5 CLASS 150 FLANGES

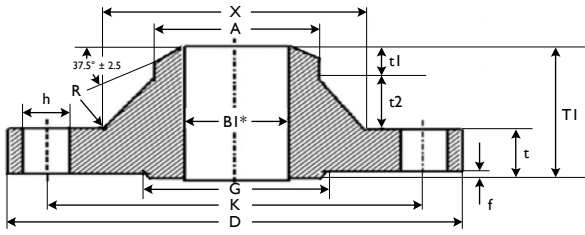

Welding Neck RF

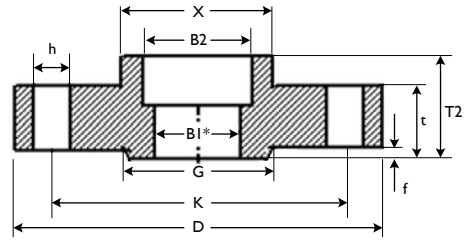

Socket Welding RF

## WELDING NECK RF STD\* DIMENSIONS (mm)

Size		Outside Diam.	Bore Diam. STD	Thick-ness	Total Thick-ness	Neck		Hub		Radius	Holes			Raised Face		Net Weight
mm	inch					D	BI*	t	T1		X	t2	t1	A	R	
15	½	120.65	15.80	22.35	60.45	38.10	30.48	7.62	21.34	3.05	22.35	4.00	82.55	35.05	6.40	1.88
20	¾	130.05	20.93	25.40	69.85	44.45	35.56	8.89	26.67	3.05	22.35	4.00	88.90	42.93	6.40	2.54
25	1	149.35	26.64	28.45	73.15	52.32	35.76	8.94	33.53	3.05	25.40	4.00	101.60	50.80	6.40	3.72
32	1¼	158.75	35.05	28.45	73.15	63.50	35.76	8.94	42.16	4.83	25.40	4.00	111.25	63.50	6.40	4.29
40	1½	177.80	40.89	31.75	82.55	69.85	40.64	10.16	48.26	6.35	28.45	4.00	123.95	73.15	6.40	5.94
50	2	215.90	52.50	38.10	101.60	104.65	50.80	12.70	60.45	7.87	25.40	8.00	165.10	91.95	6.40	10.81
65	2½	244.35	62.71	41.15	104.65	123.95	50.80	12.70	73.15	7.87	28.45	8.00	190.50	104.65	6.40	14.92
80	3	266.70	77.93	47.75	117.35	133.35	55.88	13.92	88.90	9.65	31.75	8.00	203.20	127.00	6.40	19.78
100	4	311.15	102.26	53.85	123.95	162.05	56.08	14.02	114.30	11.18	35.05	8.00	241.30	157.23	6.40	29.65
125	5	374.65	128.19	73.15	155.45	196.85	65.84	16.46	141.22	11.18	41.15	8.00	292.10	185.67	6.40	56.52
150	6	393.70	154.05	82.55	171.45	228.60	71.12	17.78	168.40	12.70	38.10	12.00	317.50	215.90	6.40	67.28
200	8	482.60	202.72	91.95	212.85	292.10	96.72	24.18	219.20	12.70	44.45	12.00	393.70	269.75	6.40	113.91
250	10	584.20	254.51	107.95	254.00	368.30	116.84	29.21	273.05	12.70	50.80	12.00	482.60	323.85	6.40	197.25
300	12	673.10	304.80	123.95	282.45	450.85	126.80	31.70	323.85	12.70	53.85	16.00	571.50	381.00	6.40	293.52
350	14	749.30	336.55	133.35	298.45	495.30	132.08	33.02	355.60	12.70	60.45	16.00	635.00	412.75	6.40	386.25
400	16	825.50	387.35	146.05	311.15	552.45	132.08	33.02	406.40	12.70	66.55	16.00	704.85	469.90	6.40	492.86
450	18	914.40	438.15	162.05	327.15	596.90	132.08	33.02	457.20	12.70	73.15	16.00	774.70	533.40	6.40	643.84
500	20	984.25	488.95	177.80	355.60	641.35	142.24	35.56	508.00	12.70	79.25	16.00	831.85	584.20	6.40	788.50

For Ring Groove face dimensions see Page 47. \*See page 48 for bore diameter all schedules (S10 to XXS)

## SOCKET WELDING RF (STD\* and XS\*) DIMENSIONS (mm)

Size		Outside Diam.	Bore Diameter STD		Bore Diameter XS		Thick-ness	Socket Depth	Total Thick-ness	Diam. at Base of Hub	Holes			Raised Face		Net Weight
mm	inch		D	B2	BI	B2					BI	t	Y	T2	X	
15	½	120.65	22.35	15.75	22.35	13.87	22.35	9.65	31.75	38.10	22.35	4.00	82.55	35.05	6.40	1.79
20	¾	130.05	27.69	20.83	27.69	18.85	25.40	11.18	35.05	44.45	22.35	4.00	88.90	42.93	6.40	2.39
25	1	149.35	34.54	26.67	34.54	24.31	28.45	12.70	41.15	52.32	25.40	4.00	101.60	50.80	6.40	3.53
32	1¼	158.75	43.18	35.05	43.18	32.46	28.45	14.22	41.15	63.50	25.40	4.00	111.25	63.50	6.40	4.03
40	1½	177.80	49.53	40.89	49.53	38.10	31.75	15.75	44.45	69.85	28.45	4.00	123.95	73.15	6.40	5.55
50	2	215.90	61.98	52.58	61.98	49.25	38.10	17.53	57.15	104.65	25.40	8.00	165.10	91.95	6.40	10.16
65	2½	244.35	74.68	62.74	74.68	59.00	41.15	19.05	63.50	123.95	28.45	8.00	190.50	104.65	6.40	14.16
80	3	266.70	90.68	77.98	90.68	73.66	47.75	20.57	73.15	133.35	31.75	8.00	203.20	127.00	6.40	18.73

For Ring Groove face dimensions see Page 47. \*See page 48 for bore diameter all schedules (S10 to XXS)

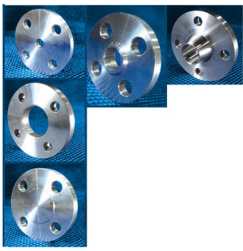

# ANSI B16.5 CLASS 1500 FLANGES

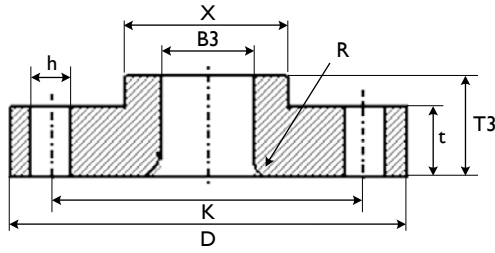

Lap Joint RF

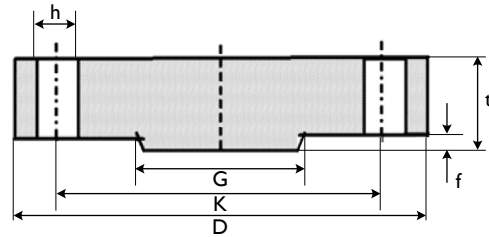

Blind RF

## LAP JOINT RF DIMENSIONS (mm)

Size		Outside Diam.	Bore Diam.	Thick-ness	Length thru Hub	Diam. at Base of Hub	Holes			Radius of Fillet	Raised Face		Net Weight
mm	inch						D	B3	t		T3	X	
15	½	120.65	22.86	22.35	31.75	38.10	22.35	4.00	82.55	3.05	35.05	6.40	1.74
20	¾	130.05	28.19	25.40	35.05	44.45	22.35	4.00	88.90	3.05	42.93	6.40	2.32
25	1	149.35	35.05	28.45	41.15	52.32	25.40	4.00	101.60	3.05	50.80	6.40	3.42
32	1¼	158.75	43.69	28.45	41.15	63.50	25.40	4.00	111.25	4.83	63.50	6.40	3.88
40	1½	177.80	50.04	31.75	44.45	69.85	28.45	4.00	123.95	6.35	73.15	6.40	5.36
50	2	215.90	62.48	38.10	57.15	104.65	25.40	8.00	165.10	7.87	91.95	6.40	9.83
65	2½	244.35	75.44	41.15	63.50	123.95	28.45	8.00	190.50	7.87	104.65	6.40	13.60
80	3	266.70	91.44	47.75	73.15	133.35	31.75	8.00	203.20	9.65	127.00	6.40	17.88
100	4	311.15	116.84	53.85	90.42	162.05	35.05	8.00	241.30	11.18	157.23	6.40	27.62
125	5	374.65	144.53	73.15	104.65	196.85	41.15	8.00	292.10	11.18	185.67	6.40	51.77
150	6	393.70	171.45	82.55	119.13	228.60	38.10	12.00	317.50	12.70	215.90	6.40	60.89
200	8	482.60	222.25	91.95	142.75	292.10	44.45	12.00	393.70	12.70	269.75	6.40	102.76
250	10	584.20	277.37	107.95	177.80	368.30	50.80	12.00	482.60	12.70	323.85	6.40	181.71
300	12	673.10	328.17	123.95	218.95	450.85	53.85	16.00	571.50	12.70	381.00	6.40	285.92
350	14	749.30	360.17	133.35	241.30	495.30	60.45	16.00	635.00	12.70	412.75	6.40	385.41
400	16	825.50	411.23	146.05	260.35	552.45	66.55	16.00	704.85	12.70	469.90	6.40	495.46
450	18	914.40	462.28	162.05	276.35	596.90	73.15	16.00	774.70	12.70	533.40	6.40	639.58
500	20	984.25	514.35	177.80	292.10	641.35	79.25	16.00	831.85	12.70	584.20	6.40	768.22
600	24	1168.40	615.95	203.20	330.20	762.00	91.95	16.00	990.60	12.70	692.15	6.40	1226.98

For Ring Groove face dimensions see Page 47.

## BLIND RF DIMENSIONS (mm)

Size		Outside Diameter	Thickness	Holes			Raised Face		Net Weight
mm	inch			D	t	Diameter	Number	P.C.D	
15	½	120.65	22.35	22.35	4.00	82.55	35.05	6.40	1.78
20	¾	130.05	25.40	22.35	4.00	88.90	42.93	6.40	2.41
25	1	149.35	28.45	25.40	4.00	101.60	50.80	6.40	3.56
32	1¼	158.75	28.45	25.40	4.00	111.25	63.50	6.40	4.13
40	1½	177.80	31.75	28.45	4.00	123.95	73.15	6.40	5.76
50	2	215.90	38.10	25.40	8.00	165.10	91.95	6.40	10.07
65	2½	244.35	41.15	28.45	8.00	190.50	104.65	6.40	13.93
80	3	266.70	47.75	31.75	8.00	203.20	127.00	6.40	19.20
100	4	311.15	53.85	35.05	8.00	241.30	157.23	6.40	29.85
125	5	374.65	73.15	41.15	8.00	292.10	185.67	6.40	58.54
150	6	393.70	82.55	38.10	12.00	317.50	215.90	6.40	71.85
200	8	482.60	91.95	44.45	12.00	393.70	269.75	6.40	121.44
250	10	584.20	107.95	50.80	12.00	482.60	323.85	6.40	210.64
300	12	673.10	123.95	53.85	16.00	571.50	381.00	6.40	316.46
350	14	749.30	133.35	60.45	16.00	635.00	412.75	6.40	420.20
400	16	825.50	146.05	66.55	16.00	704.85	469.90	6.40	558.45
450	18	914.40	162.05	73.15	16.00	774.70	533.40	6.40	760.98
500	20	984.25	177.80	79.25	16.00	831.85	584.20	6.40	965.15
600	24	1168.40	203.20	91.95	16.00	990.60	692.15	6.40	1559.56

For Ring Groove face dimensions see Page 47.



# ANSI B16.5 CLASS 1500 FLANGES

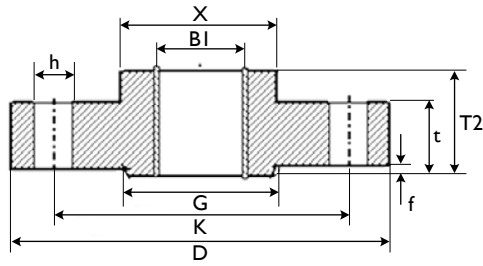

Threaded RF

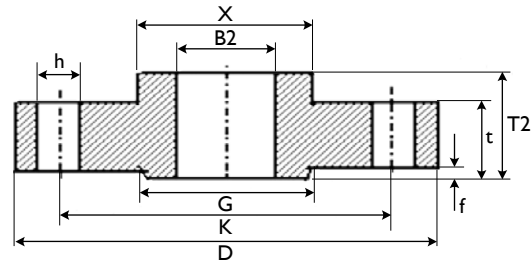

Slip On RF

## THREADED RF DIMENSIONS (mm)

Size		Outside Diam.	Bore Diam.	Thick-ness	Total Thick-ness	Diam. at Base of Hub	Thread Length	Holes			Raised Face		Net Weight
mm	inch							D	BI	t	T2	X	
15	½	120.65	22.35	22.35	31.75	38.10	22.35	22.35	4.00	82.55	35.05	6.40	1.75
20	¾	130.05	27.69	25.40	35.05	44.45	25.40	22.35	4.00	88.90	42.93	6.40	2.33
25	1	149.35	34.54	28.45	41.15	52.32	28.45	25.40	4.00	101.60	50.80	6.40	3.43
32	1¼	158.75	43.18	28.45	41.15	63.50	30.23	25.40	4.00	111.25	63.50	6.40	3.90
40	1½	177.80	49.53	31.75	44.45	69.85	31.75	28.45	4.00	123.95	73.15	6.40	5.38
50	2	215.90	61.98	38.10	57.15	104.65	38.10	25.40	8.00	165.10	91.95	6.40	9.85
65	2½	244.35	74.68	41.15	63.50	123.95	47.75	28.45	8.00	190.50	104.65	6.40	13.65
80	3	266.70	90.68	47.75	73.15	133.35	50.80	31.75	8.00	203.20	127.00	6.40	17.95
100	4	311.15	116.08	53.85	90.42	162.05	57.15	35.05	8.00	241.30	157.23	6.40	27.73
125	5	374.65	143.76	73.15	104.65	196.85	63.50	41.15	8.00	292.10	185.67	6.40	51.93
150	6	393.70	170.69	82.55	119.13	228.60	69.85	38.10	12.00	317.50	215.90	6.40	61.09
200	8	482.60	221.49	91.95	142.75	292.10	76.20	44.45	12.00	393.70	269.75	6.40	103.07
250	10	584.20	276.35	107.95	158.75	368.30	84.07	50.80	12.00	482.60	323.85	6.40	175.39
300	12	673.10	327.15	123.95	180.85	450.85	91.95	53.85	16.00	571.50	381.00	6.40	264.24

For Ring Groove face dimensions see Page 47.

## SLIP ON RF DIMENSIONS (mm)

Size		Outside Diameter	Bore Diameter	Thickness	Total Thick-ness	Diam. of Base of Hub	Holes			Raised Face		Net Weight
mm	inch						D	B2	t	T2	X	
15	½	120.65	22.35	22.35	31.75	38.10	22.35	4.00	82.55	35.05	6.40	1.75
20	¾	130.05	27.69	25.40	35.05	44.45	22.35	4.00	88.90	42.93	6.40	2.33
25	1	149.35	34.54	28.45	41.15	52.32	25.40	4.00	101.60	50.80	6.40	3.43
32	1¼	158.75	43.18	28.45	41.15	63.50	25.40	4.00	111.25	63.50	6.40	3.90
40	1½	177.80	49.53	31.75	44.45	69.85	28.45	4.00	123.95	73.15	6.40	5.38
50	2	215.90	61.98	38.10	57.15	104.65	25.40	8.00	165.10	91.95	6.40	9.85
65	2½	244.35	74.68	41.15	63.50	123.95	28.45	8.00	190.50	104.65	6.40	13.65
80	3	266.70	90.68	47.75	73.15	133.35	31.75	8.00	203.20	127.00	6.40	17.95
100	4	311.15	116.08	53.85	90.42	162.05	35.05	8.00	241.30	157.23	6.40	27.73
125	5	374.65	143.76	73.15	104.65	196.85	41.15	8.00	292.10	185.67	6.40	51.93
150	6	393.70	170.69	82.55	119.13	228.60	38.10	12.00	317.50	215.90	6.40	61.09
200	8	482.60	221.49	91.95	142.75	292.10	44.45	12.00	393.70	269.75	6.40	103.07
250	10	584.20	276.35	107.95	158.75	368.30	50.80	12.00	482.60	323.85	6.40	175.39
300	12	673.10	327.15	123.95	180.85	450.85	53.85	16.00	571.50	381.00	6.40	264.24

For Ring Groove face dimensions see Page 47.



# ANSI B16.5 CLASS 2500 FLANGES

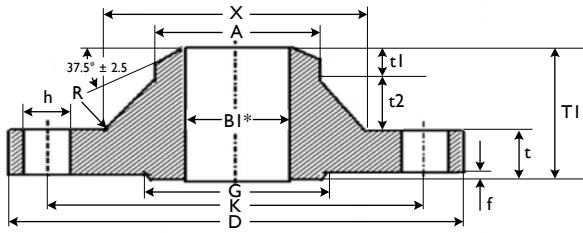

Welding Neck RF

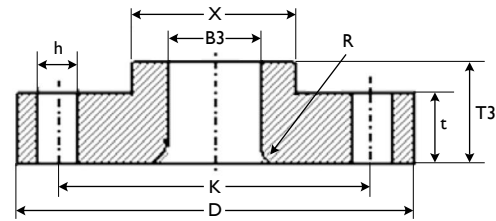

Lap Joint RF

## WELDING NECK RF STD\* DIMENSIONS (mm)

Size		Outside Diam.	Bore Diam. STD	Thick-ness	Total Thick-ness	Neck		Hub		Radius	Holes			Raised Face		Net Weight
mm	inch					Base Diam.	Thick-ness	Thick-ness	Diam.		Diam.	No.	P.C.D	Outside Diam.	Thick-ness	
mm	inch	D	BI*	t	T1	X	t2	t1	A	R	h	n	K	G	f	Kg
15	½	133.35	15.75	30.23	73.15	42.93	34.29	8.64	21.34	3.05	22.35	4.00	88.90	35.05	6.40	3.13
20	¾	139.70	20.83	31.75	79.25	50.80	38.10	9.40	26.67	3.05	22.35	4.00	95.25	42.93	6.40	3.69
25	1	158.75	26.67	35.05	88.90	57.15	43.18	10.67	33.53	3.05	25.40	4.00	107.95	50.80	6.40	5.23
32	1¼	184.15	35.05	38.10	95.25	73.15	45.72	11.43	42.16	4.83	28.45	4.00	130.05	63.50	6.40	7.73
40	1½	203.20	40.89	44.45	111.25	79.25	53.34	13.46	48.26	6.35	31.75	4.00	146.05	73.15	6.40	10.83
50	2	234.95	52.58	50.80	127.00	95.25	60.96	15.24	60.45	7.87	28.45	8.00	171.45	91.95	6.40	16.09
65	2½	266.70	62.74	57.15	142.75	114.30	68.58	17.02	73.15	7.87	31.75	8.00	196.85	104.65	6.40	23.52
80	3	304.80	77.98	66.55	166.15	133.35	81.28	20.32	88.90	9.65	35.05	8.00	228.60	127.00	6.40	35.67
100	4	355.60	102.36	76.20	190.50	165.10	91.44	22.86	114.30	11.18	41.15	8.00	273.05	157.23	6.40	54.67
125	5	419.10	128.27	91.95	228.60	203.20	109.22	27.43	141.22	11.18	47.75	8.00	323.85	185.67	6.40	90.95
150	6	482.60	154.18	107.95	273.05	234.95	132.08	33.02	168.40	12.70	53.85	8.00	368.30	215.90	6.40	140.57
200	8	552.45	202.69	127.00	317.50	304.80	152.40	38.10	219.20	12.70	53.85	12.00	438.15	269.75	6.40	210.51
250	10	673.10	254.51	165.10	419.10	374.65	203.20	50.80	273.05	12.70	66.55	12.00	539.75	323.85	6.40	399.63
300	12	762.00	304.80	184.15	463.55	441.45	223.52	55.88	323.85	12.70	73.15	12.00	619.25	381.00	6.40	566.01

For Ring Groove face dimensions see Page 47. \*See page 48 for bore diameter all schedules (S10 to XXS)

## LAP JOINT RF DIMENSIONS (mm)

Size		Outside Diam.	Bore Diam.	Thick-ness	Length thru Hub	Dia. at Base of Hub	Holes			Radius of Fillet	Raised Face		Net Weight
mm	inch						Diam.	Number	P.C.D		Outside Diam.	Thick-ness	
mm	inch	D	B3	t	T3	X	h	n	K	R	G	f	Kg
15	½	133.35	22.86	30.23	39.62	42.93	22.35	4.00	88.90	3.05	35.05	6.40	2.95
20	¾	139.70	28.19	31.75	42.93	50.80	22.35	4.00	95.25	3.05	42.93	6.40	3.44
25	1	158.75	35.05	35.05	47.75	57.15	25.40	4.00	107.95	3.05	50.80	6.40	4.84
32	1¼	184.15	43.69	38.10	52.32	73.15	28.45	4.00	130.05	4.83	63.50	6.40	7.14
40	1½	203.20	50.04	44.45	60.45	79.25	31.75	4.00	146.05	6.35	73.15	6.40	10.01
50	2	234.95	62.48	50.80	69.85	95.25	28.45	8.00	171.45	7.87	91.95	6.40	14.82
65	2½	266.70	75.44	57.15	79.25	114.30	31.75	8.00	196.85	7.87	104.65	6.40	21.43
80	3	304.80	91.44	66.55	91.95	133.35	35.05	8.00	228.60	9.65	127.00	6.40	32.43
100	4	355.60	116.84	76.20	107.95	165.10	41.15	8.00	273.05	11.18	157.23	6.40	49.73
125	5	419.10	144.53	91.95	130.05	203.20	47.75	8.00	323.85	11.18	185.67	6.40	82.72
150	6	482.60	171.45	107.95	152.40	234.95	53.85	12.00	368.30	12.70	215.90	6.40	120.03
200	8	552.45	222.25	127.00	177.80	304.80	53.85	12.00	438.15	12.70	269.75	6.40	187.59
250	10	673.10	277.37	165.10	228.60	374.65	66.55	16.00	539.75	12.70	323.85	6.40	336.66
300	12	762.00	328.17	184.15	254.00	441.45	73.15	16.00	619.25	12.70	381.00	6.40	478.77

For Ring Groove face dimensions see Page 47. \*See page 48 for bore diameter all schedules (S10 to XXS)



# ANSI B16.5 CLASS 2500 FLANGES

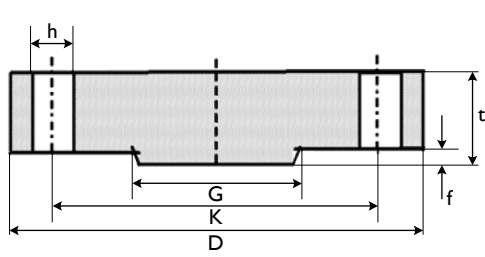

Blind RF

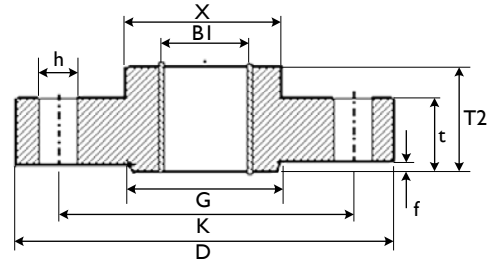

Threaded RF

## BLIND RF DIMENSIONS (mm)

Size		Outside Diameter	Thickness	Holes			Raised Face		Net Weight
mm	inch			Diameter	Number	P.C.D	Outside Diameter	Thickness	
mm	inch	D	t	h	n	K	G	f	Kg
15	½	133.35	30.23	22.35	4.00	66.55	35.05	6.40	2.99
20	¾	139.70	31.75	22.35	4.00	82.55	42.93	6.40	3.50
25	1	158.75	35.05	25.40	4.00	88.90	50.80	6.40	4.99
32	1¼	184.15	38.10	28.45	4.00	98.55	63.50	6.40	7.36
40	1½	203.20	44.45	31.75	4.00	114.30	73.15	6.40	10.42
50	2	234.95	50.80	28.45	8.00	127.00	91.95	6.40	15.59
65	2½	266.70	57.15	31.75	8.00	149.35	104.65	6.40	22.65
80	3	304.80	66.55	35.05	8.00	168.15	127.00	6.40	34.72
100	4	355.60	76.20	41.15	8.00	200.15	157.23	6.40	54.01
125	5	419.10	91.95	47.75	8.00	234.95	185.67	6.40	90.58
150	6	482.60	107.95	53.85	12.00	269.75	215.90	6.40	133.67
200	8	552.45	127.00	53.85	12.00	330.20	269.75	6.40	214.58
250	10	673.10	165.10	66.55	16.00	387.35	323.85	6.40	393.15
300	12	762.00	184.15	73.15	16.00	450.85	381.00	6.40	567.72

For Ring Groove face dimensions see Page 47.

## THREADED RF DIMENSIONS (mm)

Size		Outside Diam.	Bore Diam.	Thick-ness	Total Thick-ness	Dia. at Base of Hub	Thread length	Holes			Raised Face		Net Weight
mm	inch							Diam.	Number	P.C.D	Outside Diam.	Thick-ness	
mm	inch	D	B2	t	T2	X	Q	h	n	K	G	f	Kg
15	½	133.35	22.35	30.23	39.62	42.93	28.45	22.35	4.00	88.90	35.05	6.40	2.96
20	¾	139.70	27.69	31.75	42.93	50.80	31.75	22.35	4.00	95.25	42.93	6.40	3.45
25	1	158.75	34.54	35.05	47.75	57.15	35.05	25.40	4.00	107.95	50.80	6.40	4.85
32	1¼	184.15	43.18	38.10	52.32	73.15	38.10	28.45	4.00	130.05	63.50	6.40	7.16
40	1½	203.20	49.53	44.45	60.45	79.25	44.45	31.75	4.00	146.05	73.15	6.40	10.03
50	2	234.95	61.98	50.80	69.85	95.25	50.80	28.45	8.00	171.45	91.95	6.40	14.85
65	2½	266.70	74.68	57.15	79.25	114.30	57.15	31.75	8.00	196.85	104.65	6.40	21.49
80	3	304.80	90.68	66.55	91.95	133.35	63.50	35.05	8.00	228.60	127.00	6.40	32.52
100	4	355.60	118.08	76.20	107.95	165.10	69.85	41.15	8.00	273.05	157.23	6.40	49.85
125	5	419.10	143.76	91.95	130.05	203.20	76.20	47.75	8.00	323.85	185.67	6.40	82.90
150	6	482.60	170.69	107.95	152.40	234.95	82.55	53.85	8.00	368.30	215.90	6.40	128.01
200	8	552.45	221.49	127.00	177.80	304.80	95.25	53.85	12.00	438.15	269.75	6.40	187.97
250	10	673.10	276.35	165.10	228.60	374.65	107.95	66.55	12.00	539.75	323.85	6.40	355.51
300	12	762.00	327.15	184.15	254.00	441.45	120.65	73.15	12.00	619.25	381.00	6.40	504.15

For Ring Groove face dimensions see Page 47.

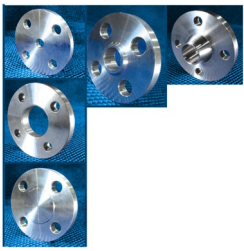

# ANSI B16.5 CLASS 2500 FLANGES

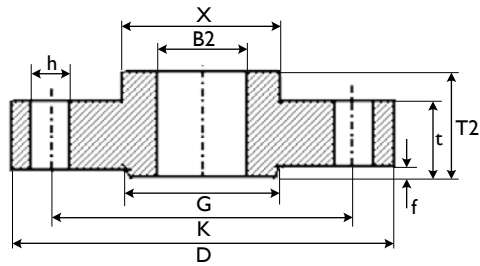

Slip On RF

## SLIP ON RF DIMENSIONS (mm)

Size		Outside Diam.	Bore Diam.	Thick-ness	Total Thick-ness	Dia. at Base of Hub	Holes			Raised Face		Net Weight
mm	inch						Diam.	Number	P.C.D	Outside Diam.	Thick-ness	
mm	inch	D	B2	t	T2	X	h	n	K	G	f	Kg
15	½	133.35	22.35	30.23	39.62	42.93	22.35	4.00	88.90	35.05	6.40	2.96
20	¾	139.70	27.69	31.75	42.93	50.80	22.35	4.00	95.25	42.93	6.40	3.45
25	1	158.75	34.54	35.05	47.75	57.15	25.40	4.00	107.95	50.80	6.40	4.85
32	1¼	184.15	43.18	38.10	52.32	73.15	28.45	4.00	130.05	63.50	6.40	7.16
40	1½	203.20	49.53	44.45	60.45	79.25	31.75	4.00	146.05	73.15	6.40	10.03
50	2	234.95	61.98	50.80	69.85	95.25	28.45	8.00	171.45	91.95	6.40	14.85
65	2½	266.70	74.68	57.15	79.25	114.30	31.75	8.00	196.85	104.65	6.40	21.49
80	3	304.80	90.68	66.55	91.95	133.35	35.05	8.00	228.60	127.00	6.40	32.52
100	4	355.60	116.08	76.20	107.95	165.10	41.15	8.00	273.05	157.23	6.40	49.85
125	5	419.10	143.76	91.95	130.05	203.20	47.75	8.00	323.85	185.67	6.40	82.90
150	6	482.60	170.69	107.95	152.40	234.95	53.85	8.00	368.30	215.90	6.40	128.01
200	8	552.45	221.49	127.00	177.80	304.80	53.85	12.00	438.15	269.75	6.40	187.97
250	10	673.10	276.35	165.10	228.60	374.65	66.55	12.00	539.75	323.85	6.40	355.51
300	12	762.00	327.15	184.15	254.00	441.45	73.15	12.00	619.25	381.00	6.40	504.15

For Ring Groove face dimensions see Page 47.

(17)

**Table 15 Templates for Drilling Class 600 Pipe Flanges and Flanged Fittings**

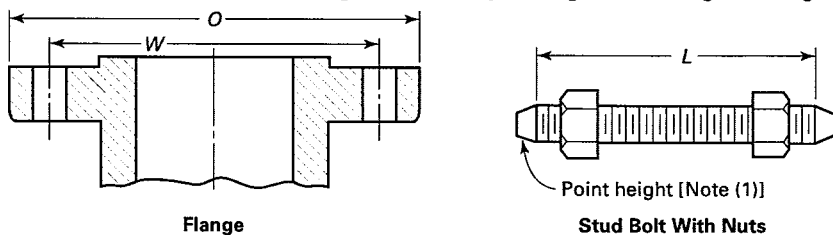

1 Nominal Pipe Size, NPS	2 Outside Diameter of Flange, O	3 Drilling [Notes (2), (3)]				4 Length of Bolts, L [Notes (1), (4)]		
		5 Diameter of Bolt Circle, W	6 Diameter of Bolt Holes, in.	7 Number of Bolts	8 Diameter of Bolts, in.	9 7-mm Raised Face	10 Male and Female/ Tongue and Groove	11 Ring Joint
1/2	95	66.7	5/8	4	1/2	75	70	75
3/4	115	82.6	3/4	4	5/8	90	85	90
1	125	88.9	3/4	4	5/8	90	85	90
1 1/4	135	98.4	3/4	4	5/8	95	90	95
1 1/2	155	114.3	7/8	4	3/4	110	100	110
2	165	127.0	3/4	8	5/8	110	100	110
2 1/2	190	149.2	7/8	8	3/4	120	115	120
3	210	168.3	7/8	8	3/4	125	120	125
3 1/2	230	184.2	1	8	7/8	140	135	140
4	275	215.9	1	8	7/8	145	140	145
5	330	266.7	1 1/8	8	1	165	160	165
6	355	292.1	1 1/8	12	1	170	165	170
8	420	349.2	1 1/4	12	1 1/8	190	185	195
10	510	431.8	1 3/8	16	1 1/4	215	210	215
12	560	489.0	1 3/8	20	1 1/4	220	215	220
14	605	527.0	1 1/2	20	1 3/8	235	230	235
16	685	603.2	1 5/8	20	1 1/2	255	250	255
18	745	654.0	1 3/4	20	1 5/8	275	265	275
20	815	723.9	1 3/4	24	1 5/4	285	280	290
22	870	777.7	1 7/8	24	1 3/4	305	...	310
24	940	838.2	2	24	1 7/8	330	325	335

**GENERAL NOTES:**

- (a) Dimensions of Table 15 are in millimeters, except for the diameters of the bolts and bolt holes, which are expressed in inch units. For dimensions in inch units, refer to Mandatory Appendix II, Table II-15.
- (b) For other dimensions, see Table 16.

**NOTES:**

- (1) The length of the stud bolt does not include the height of the points (see para 6.10.2).
- (2) For flange bolt holes, see para. 6.5.
- (3) For spot facing, see para 6.6.
- (4) Bolt lengths not shown in the table may be in accordance with Nonmandatory Appendix C (see para. 6.10.2).



(17)

Table 16 Dimensions of Class 600 Flanges

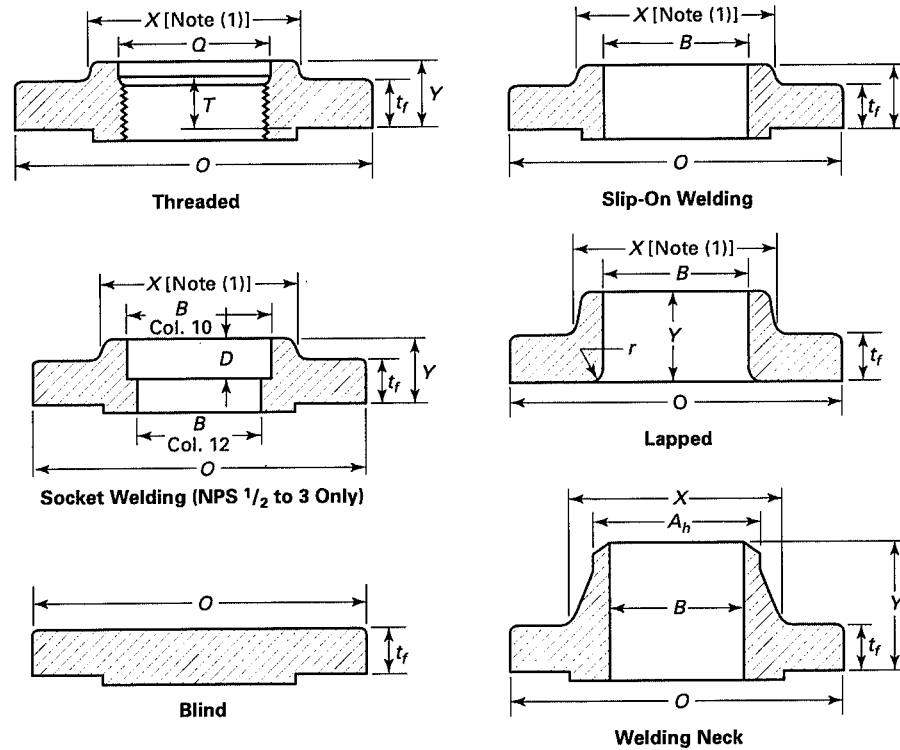

97

1	2	3	4	5	6			8	9	10			12	13	14	15
Nominal Pipe Size, NPS	Outside Diameter of Flange, O	Minimum Thickness of Flange, $t_f$	Diameter of Hub, X	Hub Diameter Beginning of Chamfer Welding Neck, $A_h$ [Note (2)]	Length Through Hub			Welding Neck, Y	Minimum Thread Length Threaded Flange, T [Note (3)]	Bore			Welding Neck/Socket Welding, B	Corner Bore Radius of Lapped Flange and Pipe, r	Minimum Counterbore Threaded Flange, Q	Depth of Socket, D
					Threaded/Slip-On/Socket Welding, Y	Lapped, Y	Welding Neck, Y			Minimum Slip-On/Socket Welding, B	Minimum Lapped, B					
1/2	95	14.3	38	21.3	22	22	52	16	22.2	22.9	Note (4)	3	23.6	10		
3/4	115	15.9	48	26.7	25	25	57	16	27.7	28.2	Note (4)	3	29.0	11		
1	125	17.5	54	33.4	27	27	62	18	34.5	34.9	Note (4)	3	35.8	13		
1 1/4	135	20.7	64	42.2	29	29	67	21	43.2	43.7	Note (4)	5	44.4	14		
1 1/2	155	22.3	70	48.3	32	32	70	23	49.5	50.0	Note (4)	6	50.6	16		
2	165	25.4	84	60.3	37	37	73	29	61.9	62.5	Note (4)	8	63.5	17		

(17)

Table 16 Dimensions of Class 600 Flanges (Cont'd)

1	2	3	4	5	6			7	8	9	10		11	12	13	14	15
Nominal Pipe Size, NPS	Outside Diameter of Flange, <i>O</i>	Minimum Thickness of Flange, <i>t<sub>f</sub></i>	Diameter of Hub, <i>X</i>	Hub Diameter Beginning of Chamfer Welding Neck, <i>A<sub>h</sub></i> [Note (2)]	Length Through Hub			Welding Neck, <i>Y</i>	Minimum Thread Length Threaded Flange, <i>T</i> [Note (3)]	Bore		Welding Neck/ Socket Welding, <i>B</i>	Corner Bore Radius of Lapped Flange and Pipe, <i>r</i>	Minimum Counterbore Threaded Flange, <i>Q</i>	Depth of Socket, <i>D</i>		
					Threaded/ Slip-On/ Socket Welding, <i>Y</i>	Lapped, <i>Y</i>	Minimum Slip-On/ Socket Welding, <i>B</i>			Minimum Lapped, <i>B</i>							
2½	190	28.6	100	73.0	41	41	79	32	74.6	75.4	Note (4)	8	76.2	19			
3	210	31.8	117	88.9	46	46	83	35	90.7	91.4	Note (4)	10	92.2	21			
3½	230	35.0	133	101.6	49	49	86	40	103.4	104.1	Note (4)	10	104.9	...			
4	275	38.1	152	114.3	54	54	102	42	116.1	116.8	Note (4)	11	117.6	...			
5	330	44.5	189	141.3	60	60	114	48	143.8	144.4	Note (4)	11	144.4	...			
6	355	47.7	222	168.3	67	67	117	51	170.7	171.4	Note (4)	13	171.4	...			
8	420	55.6	273	219.1	76	76	133	58	221.5	222.2	Note (4)	13	222.2	...			
10	510	63.5	343	273.0	86	111	152	66	276.2	277.4	Note (4)	13	276.2	...			
12	560	66.7	400	323.8	92	117	156	70	327.0	328.2	Note (4)	13	328.6	...			
14	605	69.9	432	355.6	94	127	165	74	359.2	360.2	Note (4)	13	360.4	...			
16	685	76.2	495	406.4	106	140	178	78	410.5	411.2	Note (4)	13	411.2	...			
18	745	82.6	546	457.0	117	152	184	80	461.8	462.3	Note (4)	13	462.0	...			
20	815	88.9	610	508.0	127	165	190	83	513.1	514.4	Note (4)	13	512.8	...			
22	870	95.2	663	558.8	133	175	197	...	564.4	565.2	Note (4)	13	...	...			
24	940	101.6	718	610.0	140	184	203	93	616.0	616.0	Note (4)	13	614.4	...			

## GENERAL NOTES:

- (a) Dimensions of Table 16 are in millimeters. For dimensions in inch units, refer to Mandatory Appendix II, Table II-16.  
 (b) For tolerance, see section 7.  
 (c) For facings, see para. 6.4.  
 (d) For flange bolt holes, see para. 6.5 and Table 15.  
 (e) For spot facing, see para. 6.6.  
 (f) For reducing threaded and slip-on flanges, see Table 6.  
 (g) Blind flanges may be made with or without hubs at the manufacturer's option.  
 (h) For reducing welding neck flanges, see para. 6.8.

## NOTES:

- (1) This dimension is for the large end of the hub, which may be straight or tapered. Taper shall not exceed 7 deg on threaded, slip-on, socket-welding, and lapped flanges. This dimension is defined as the diameter at the intersection between the hub taper and back face of the flange.  
 (2) For welding end bevel, see para. 6.7.  
 (3) For thread of threaded flanges, see para. 6.9.  
 (4) To be specified by the purchaser.

98

Table 18 Dimensions of Class 900 Flanges

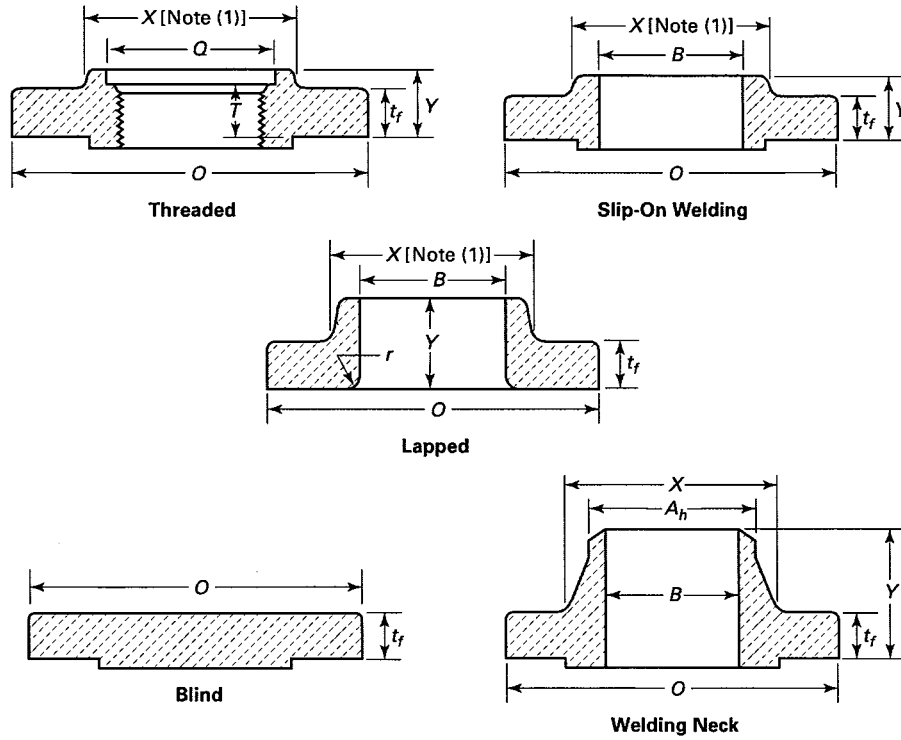

1	2	3	4	5	Length Through Hub			Bore			13	14	
					6	7	8	9	10	11			12
Nom. Pipe Size, NPS	Outside Diam. of Flange, <i>O</i>	Min. Thickness of Flange, <i>t<sub>f</sub></i>	Diam. of Hub, <i>X</i>	Hub Diam. Beginning of Chamfer Welding Neck, <i>A<sub>n</sub></i> [Note (2)]	Threaded/ Slip-On, <i>Y</i>	Lapped, <i>Y</i>	Welding Neck, <i>Y</i>	Minimum Thread Length Threaded Flange, <i>T</i> [Note (3)]	Min. Slip-On, <i>B</i>	Min. Lapped, <i>B</i>	Welding Neck, <i>B</i>	Corner Bore Radius of Lapped Flange and Pipe, <i>r</i>	Minimum Counterbore Threaded Flange, <i>Q</i>
1/2													
3/4													
1													
1 1/4													
1 1/2													
2													
2 1/2													
3	240	38.1	127	88.9	54	54	102	42	90.7	91.4	Note (5)	10	92.2
4	290	44.5	159	114.3	70	70	114	48	116.1	116.8	Note (5)	11	117.6
5	350	50.8	190	141.3	79	79	127	54	143.8	144.4	Note (5)	11	144.4
6	380	55.6	235	168.3	86	86	140	58	170.7	171.4	Note (5)	13	171.4
8	470	63.5	298	219.1	102	114	162	64	221.5	222.2	Note (5)	13	222.2
10	545	69.9	368	273.0	108	127	184	72	276.2	277.4	Note (5)	13	276.2
12	610	79.4	419	323.8	117	143	200	77	327.0	328.2	Note (5)	13	328.6
14	640	85.8	451	355.6	130	156	213	83	359.2	360.2	Note (5)	13	360.4
16	705	88.9	508	406.4	133	165	216	86	410.5	411.2	Note (5)	13	411.2
18	785	101.6	565	457.0	152	190	229	89	461.8	462.3	Note (5)	13	462.0

Use Class 1500 dimensions in these sizes [Note (4)]

Table 18 Dimensions of Class 900 Flanges (Cont'd)

1	2	3	4	5	6	7	8	9	10	11	12	13	14
Nom. Pipe Size, NPS	Outside Diam. of Flange, <i>O</i>	Min. Thickness of Flange, <i>t<sub>f</sub></i>	Diam. of Hub, <i>X</i>	Hub Diam. Beginning of Chamfer of Neck, <i>A<sub>h</sub></i> [Note (2)]	Length Through Hub			Minimum Thread Length of Threaded Flange, <i>T</i> [Note (3)]	Bore			Corner Bore Radius of Lapped Flange and Pipe, <i>r</i>	Minimum Counterbore of Threaded Flange, <i>Q</i>
					Threaded/ Slip-On, <i>Y</i>	Lapped, <i>Y</i>	Welding Neck, <i>Y</i>		Min. Slip-On, <i>B</i>	Min. Lapped, <i>B</i>	Welding Neck, <i>B</i>		
20	855	108.0	622	508.0	159	210	248	93	513.1	514.4	Note (5)	13	512.8
24	1,040	139.7	749	610.0	203	267	292	102	616.0	616.0	Note (5)	13	614.4

## GENERAL NOTES:

- (a) Dimensions of Table 18 are in millimeters. For dimensions in inch units, refer to Mandatory Appendix II, Table II-18.  
 (b) For tolerances, see section 7.  
 (c) For facings, see para. 6.4.  
 (d) For flange bolt holes, see para. 6.5 and Table 17.  
 (e) For spot facing, see para. 6.6.  
 (f) For reducing threaded and slip-on flanges, see Table 6.  
 (g) Blind flanges may be made with or without hubs at the manufacture's option.  
 (h) For reducing welding neck flanges, see para. 6.8.

## NOTES:

- (1) This dimension is for the large end of the hub, which may be straight or tapered. Taper shall not exceed 7 deg on threaded, slip-on, socket-welding, and lapped flanges. This dimension is defined as the diameter at the intersection between the hub taper and back face of the flange.  
 (2) For welding end bevel, see para. 6.7.  
 (3) For thread of threaded flanges, see para. 6.9.  
 (4) Socket welding flanges may be provided in NPS 1/2 through NPS 2 1/2, using Class 1500 dimensions.  
 (5) To be specified by the purchaser.

Table 19 Templates for Drilling Class 1500 Pipe Flanges

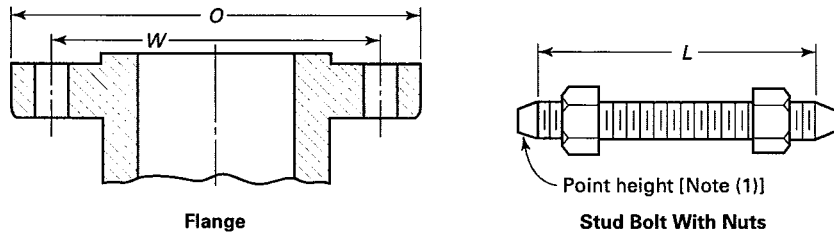

1 Nominal Pipe Size, NPS	2 Outside Diameter of Flange, O	3 Drilling [Notes (2), (3)]				7 Length of Bolts, L [Notes (1), (4)]		
		3 Diameter of Bolt Circle, W	4 Diameter of Bolt Holes, in.	5 Number of Bolts	6 Diameter of Bolts, in.	7 7-mm	8 Male and Female/ Tongue and Groove	9 Ring Joint
						Raised Face		
1/2	120	82.6	7/8	4	3/4	110	100	110
3/4	130	88.9	7/8	4	3/4	115	110	115
1	150	101.6	1	4	7/8	125	120	125
1 1/4	160	111.1	1	4	7/8	125	120	125
1 1/2	180	123.8	1 1/8	4	1	140	135	140
2	215	165.1	1	8	7/8	145	140	145
2 1/2	245	190.5	1 1/8	8	1	160	150	160
3	265	203.2	1 1/4	8	1 1/8	180	170	180
4	310	241.3	1 3/8	8	1 1/4	195	190	195
5	375	292.1	1 5/8	8	1 1/2	250	240	250
6	395	317.5	1 1/2	12	1 3/8	260	255	265
8	485	393.7	1 3/4	12	1 5/8	290	285	300
10	585	482.6	2	12	1 7/8	335	330	345
12	675	571.5	2 1/8	16	2	375	370	385
14	750	635.0	2 3/8	16	2 1/4	405	400	425
16	825	704.8	2 5/8	16	2 1/2	445	440	470
18	915	774.7	2 7/8	16	2 3/4	495	490	525
20	985	831.8	3 1/8	16	3	540	535	565
24	1 170	990.6	3 3/8	16	3 1/2	615	610	650

GENERAL NOTES:

- (a) Dimensions of Table 19 are in millimeters, except for the diameters of the bolts and bolt holes, which are in inch units. For dimensions in inch units, refer to Mandatory Appendix II, Table II-19.
- (b) For other dimensions, see Table 20.

NOTES:

- (1) The length of the stud bolt does not include the height of the points (see para. 6.10.2).
- (2) For flange bolt holes, see para. 6.5.
- (3) For spot facing, see para. 6.6.
- (4) Bolt lengths not shown in the table may be determined in accordance with Nonmandatory Appendix C (see para. 6.10.2).

Table 20 Dimensions of Class 1500 Flanges

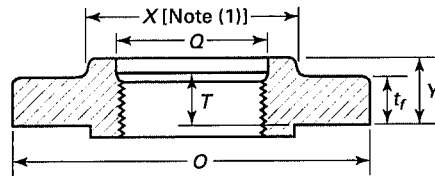

Threaded (NPS 1/2 to 2 1/2 Only)

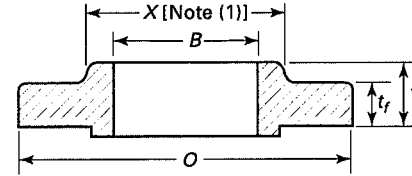

Slip-On Welding (NPS 1/2 to 2 1/2 Only)

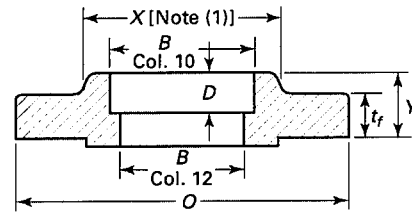

Socket Welding (NPS 1/2 to 2 1/2 Only)

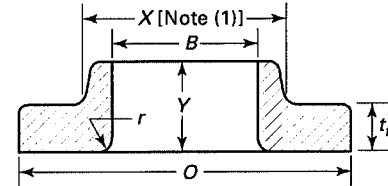

Lapped

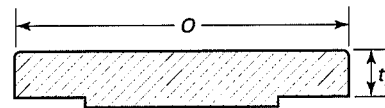

Blind

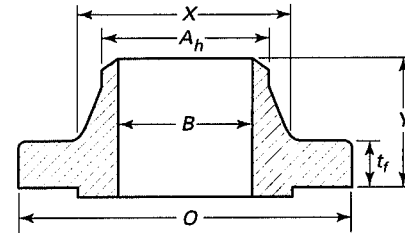

Welding Neck

103

ASME B16.5-2017

1	2	3	4	5	6	7	8	9	10	11	12	13	14	15
Nominal Pipe Size, NPS	Outside Diameter of Flange, O	Minimum Thickness of Flange, t <sub>f</sub>	Diameter of Hub, X	Hub Diameter Beginning of Chamfer Welding Neck, A <sub>h</sub> [Note (2)]	Length Through Hub			Minimum Thread Length Threaded Flange, T [Note (3)]	Bore			Corner Bore Radius of Lapped Flange and Pipe, r	Minimum Counterbore Threaded Flange, Q	Depth of Socket, D
					Threaded/ Slip-On/ Socket Welding, Y	Lapped, Y	Welding Neck, Y		Minimum Slip-On/ Socket Welding, B	Minimum Lapped, B	Welding Neck/ Socket Welding, B			
1/2	120	22.3	38	21.3	32	32	60	23	22.2	22.9	Note (4)	3	23.6	10
3/4	130	25.4	44	26.7	35	35	70	26	27.7	28.2	Note (4)	3	29.0	11
1	150	28.6	52	33.4	41	41	73	29	34.5	34.9	Note (4)	3	35.8	13
1 1/4	160	28.6	64	42.2	41	41	73	31	43.2	43.7	Note (4)	5	44.4	14
1 1/2	180	31.8	70	48.3	44	44	83	32	49.5	50.0	Note (4)	6	50.6	16
2	215	38.1	105	60.3	57	57	102	39	61.9	62.5	Note (4)	8	63.5	17
2 1/2	245	41.3	124	73.0	64	64	105	48	74.6	75.4	Note (4)	8	76.2	19

Table 20 Dimensions of Class 1500 Flanges (Cont'd)

1	2	3	4	5	6			8	9	10		11	12	13	14	15
Nominal Pipe Size, NPS	Outside Diameter of Flange, <i>O</i>	Minimum Thickness of Flange, <i>t<sub>f</sub></i>	Diameter of Hub, <i>X</i>	Hub Diameter Beginning of Chamfer Welding Neck, <i>A<sub>n</sub></i> [Note (2)]	Length Through Hub			Welding Neck, <i>Y</i>	Minimum Thread Length Threaded Flange, <i>T</i> [Note (3)]	Bore		Welding Neck/ Socket Welding, <i>B</i>	Corner Bore Radius of Lapped Flange and Pipe, <i>r</i>	Minimum Counterbore Threaded Flange, <i>Q</i>	Depth of Socket, <i>D</i>	
					Threaded/ Slip-On/ Socket Welding, <i>Y</i>	Lapped, <i>Y</i>	Welding Neck, <i>Y</i>			Minimum Slip-On/ Socket Welding, <i>B</i>	Minimum Lapped, <i>B</i>					
3	265	47.7	133	88.9	...	73	117	...	...	91.4	Note (4)	10	...	...		
4	310	54.0	162	114.3	...	90	124	...	...	116.8	Note (4)	11	...	...		
5	375	73.1	197	141.3	...	105	156	...	...	144.4	Note (4)	11	...	...		
6	395	82.6	229	168.3	...	119	171	...	...	171.4	Note (4)	13	...	...		
8	485	92.1	292	219.1	...	143	213	...	...	222.2	Note (4)	13	...	...		
10	585	108.0	368	273.0	...	178	254	...	...	277.4	Note (4)	13	...	...		
12	675	123.9	451	323.8	...	219	283	...	...	328.2	Note (4)	13	...	...		
14	750	133.4	495	355.6	...	241	298	...	...	360.2	Note (4)	13	...	...		
16	825	146.1	552	406.4	...	260	311	...	...	411.2	Note (4)	13	...	...		
18	915	162.0	597	457.0	...	276	327	...	...	462.3	Note (4)	13	...	...		
20	985	177.8	641	508.0	...	292	356	...	...	514.4	Note (4)	13	...	...		
24	1 170	203.2	762	610.0	...	330	406	...	...	616.0	Note (4)	13	...	...		

GENERAL NOTES:

- (a) Dimensions of Table 20 are in millimeters. For dimensions in inch units, refer to Mandatory Appendix II, Table II-20.
- (b) For tolerances, see section 7.
- (c) For facings, see para. 6.4.
- (d) For flange bolt holes, see para. 6.5 and Table 19.
- (e) For spot facing, see para 6.6.
- (f) For reducing threaded and slip-on flanges, see Table 6.
- (g) Blind flanges may be made with or without hubs at the manufacturer's option.
- (h) For reducing welding neck flanges, see para 6.8.

NOTES:

- (1) This dimension is for the large end of the hub, which may be straight or tapered. Taper shall not exceed 7 deg on threaded, slip-on, socket-welding, and lapped flanges. This dimension is defined as the diameter at the intersection between the hub taper and back face of the flange.
- (2) For welding end bevel, see para. 6.7.
- (3) For thread of threaded flanges, see para. 6.9.
- (4) To be specified by the purchaser.

Table 21 Templates for Drilling Class 2500 Pipe Flanges

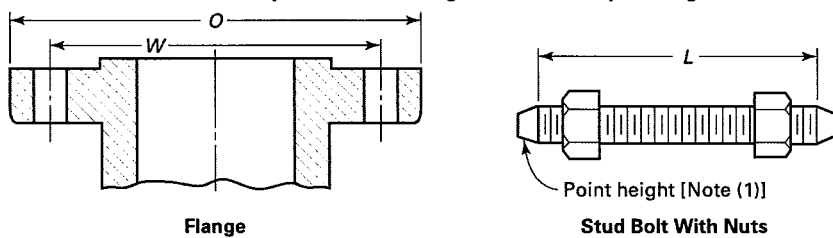

1 Nominal Pipe Size, NPS	2 Outside Diameter of Flange, O	3 Drilling [Notes (2), (3)]			5 Diameter of Bolts, in.	7 Length of Bolts, L [Notes (1), (4)]		
		3 Diameter of Bolt Circle, W	4 Diameter of Bolt Holes, in.	4 Number of Bolts		7 7-mm Raised Face	8 Male and Female/ Tongue and Groove	9 Ring Joint
1/2	135	88.9	7/8	4	3/4	120	115	120
3/4	140	95.2	7/8	4	3/4	125	120	125
1	160	108.0	1	4	7/8	140	135	140
1 1/4	185	130.2	1 1/8	4	1	150	145	150
1 1/2	205	146.0	1 1/4	4	1 1/8	170	165	170
2	235	171.4	1 1/8	8	1	180	170	180
2 1/2	265	196.8	1 1/4	8	1 1/8	195	190	205
3	305	228.6	1 3/8	8	1 1/4	220	215	230
4	355	273.0	1 5/8	8	1 1/2	255	250	260
5	420	323.8	1 7/8	8	1 3/4	300	290	310
6	485	368.3	2 1/8	8	2	345	335	355
8	550	438.2	2 1/8	12	2	380	375	395
10	675	539.8	2 5/8	12	2 1/2	490	485	510
12	760	619.1	2 7/8	12	2 3/4	540	535	560

GENERAL NOTES:

- (a) Dimensions of Table 21 are in millimeters, except for diameters of bolts and bolt holes, which are in inch units. For dimensions in inch units, refer to Mandatory Appendix II, Table II-21.
- (b) For other dimensions, see Table 22.

NOTES:

- (1) The length of the stud bolt does not include the height of the points (see para. 6.10.2).
- (2) For flange bolt holes, see para. 6.5.
- (3) For spot facing, see para. 6.6.
- (4) Bolt lengths not shown in the table may be determined with Nonmandatory Appendix C (see para. 6.10.2).



Table 22 Dimensions of Class 2500 Flanges

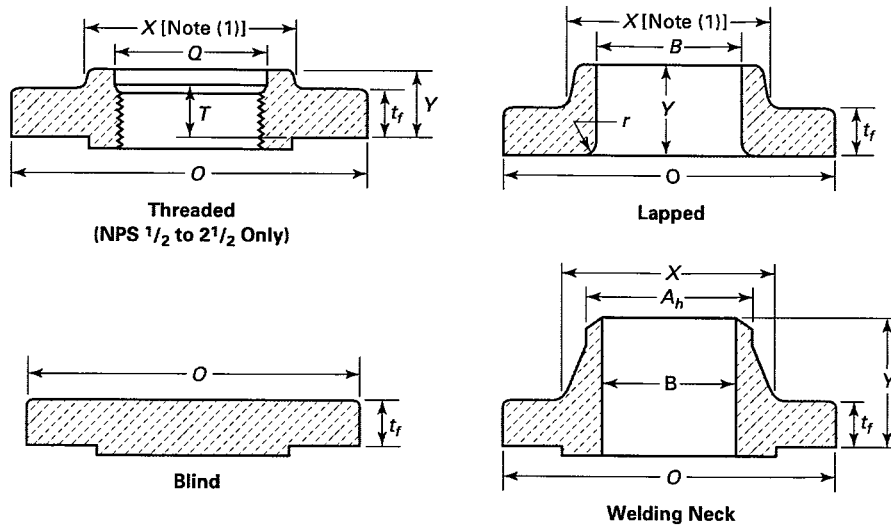

1	2	3	4	5	Length Through Hub			8	Bore		12	13
					6	7	8		9	10		
Nom. Pipe Size, NPS	Outside Diam. of Flange, $O$	Min. Thickness of Flange, $t_f$	Diam. of Hub, $X$	Hub Diam. Beginning of Chamfer of Welding Neck, $A_h$ [Note (2)]	Threaded, $Y$	Lapped, $Y$	Welding Neck, $Y$	Minimum Thread Length Threaded Flange, $T$ [Note (3)]	Min. Lapped, $B$	Welding Neck, $B$	Corner Bore Radius of Lapped Flange and Pipe, $r$	Minimum Counterbore Threaded Flange, $Q$
1/2	135	30.2	43	21.3	40	40	73	29	22.9	Note (4)	3	23.6
3/4	140	31.8	51	26.7	43	43	79	32	28.2	Note (4)	3	29.0
1	160	35.0	57	33.4	48	48	89	35	34.9	Note (4)	3	35.8
1 1/4	185	38.1	73	42.2	52	52	95	39	43.7	Note (4)	5	44.4
1 1/2	205	44.5	79	48.3	60	60	111	45	50.0	Note (4)	6	50.6
2	235	50.9	95	60.3	70	70	127	51	62.5	Note (4)	8	63.5
2 1/2	265	57.2	114	73.0	79	79	143	58	75.4	Note (4)	8	76.2
3	305	66.7	133	88.9	...	92	168	...	91.4	Note (4)	10	...
4	355	76.2	165	114.3	...	108	190	...	116.8	Note (4)	11	...
5	420	92.1	203	141.3	...	130	229	...	144.4	Note (4)	11	...
6	485	108.0	235	168.3	...	152	273	...	171.4	Note (4)	13	...
8	550	127.0	305	219.1	...	178	318	...	222.2	Note (4)	13	...
10	675	165.1	375	273.0	...	229	419	...	277.4	Note (4)	13	...
12	760	184.2	441	323.8	...	254	464	...	328.2	Note (4)	13	...

GENERAL NOTES:

- (a) Dimensions of Table 22 are in millimeters, except for diameters of bolts and bolt holes, which are in inch units. For dimensions in inch units, refer to Mandatory Appendix II, Table II-22.
- (b) For tolerances, see section 7.
- (c) For facings, see para. 6.4.
- (d) For flange bolt holes, see para. 6.5 and Table 21.
- (e) For spot facing, see para 6.6.
- (f) For reducing threaded and slip-on flanges, see Table 6.
- (g) Blind flanges may be made with or without hubs at the manufacturer's option.
- (h) For reducing welding neck flanges, see para 6.8.

NOTES:

- (1) This dimension is for the large end of the hub, which may be straight or tapered. Taper shall not exceed 7 deg on threaded and lapped flanges. This dimension is defined as the diameter at the intersection between the hub taper and back face of the flange.

Table 17 Templates for Drilling Class 900 Pipe Flanges and Flanged Fittings

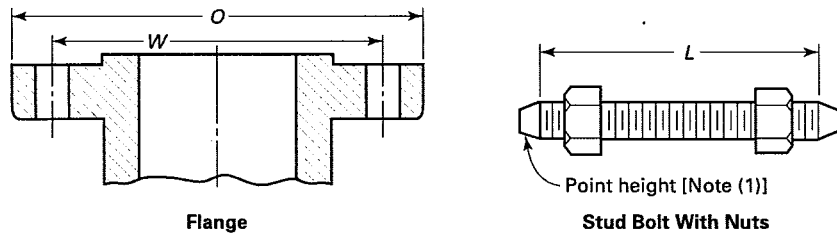

Nominal Pipe Size, NPS	Outside Diameter of Flange, O	Drilling [Notes (2), (3)]				Length of Bolts, L [Notes (1), (4)]		
		Diameter of Bolt Circle, W	Diameter of Bolt Holes, in.	Number of Bolts	Diameter of Bolts, in.	7-mm Raised Face	Male and Female/Tongue and Groove	Ring Joint
1/2								
3/4								
1								
Use Class 1500 dimensions in these sizes								
1 1/4								
1 1/2								
2								
2 1/2								
3	240	190.5	1	8	7/8	145	140	145
4	290	235.0	1 1/4	8	1 1/8	170	165	170
5	350	279.4	1 3/8	8	1 1/4	190	185	190
6	380	317.5	1 1/2	12	1 1/8	190	185	195
8	470	393.7	1 1/2	12	1 3/8	220	215	220
10	545	469.9	1 1/2	16	1 3/8	235	230	235
12	610	533.4	1 1/2	20	1 3/8	255	250	255
14	640	558.8	1 5/8	20	1 1/2	275	265	280
16	705	616.0	1 3/4	20	1 5/8	285	280	290
18	785	685.8	2	20	1 7/8	325	320	335
20	855	749.3	2 1/8	20	2	350	345	360
24	1,040	901.7	2 5/8	20	2 1/2	440	430	455

GENERAL NOTES:

- (a) Dimensions of Table 17 are in millimeters, except for diameters of bolts and bolt holes, which are in inch units. For dimensions in inch units, refer to Mandatory Appendix II, Table II-17.
- (b) For other dimensions, see Tables 18 and 19.

NOTES:

- (1) The length of the stud bolt does not include the height of the points (see para 6.10.2).
- (2) For flange bolt holes, see para. 6.5.
- (3) For spot facing, see para. 6.6.
- (4) Bolt lengths not shown in the table may be determined in accordance with Nonmandatory Appendix C (see para. 6.10.2).